



The Mercedes-Benz Sprinter.

Model information & price list.

Prices effective from January 2019 production.

Mercedes-Benz

Vans. Born to run.



The Mercedes-Benz Sprinter.

Business has always been about making the right connections. Take yours to the next level with the Mercedes-Benz Sprinter.

With an enhanced cabin environment and the highest standard specification of any large van, the Sprinter is better than ever. It's also safer than ever, with more sixth sense safety features as standard.

More versatile than ever, with the introduction of a lowloading height front wheel drive model - the first series production van with the 9G-TRONIC 9-speed automatic transmission, to help increase efficiency and payload.

And it's factory-ready for the future, to improve your operations from day one. Every Sprinter is powered by Mercedes PRO connect - more than just a telematics solution, this complete vehicle support tool powerfully and intelligently connects businesses, drivers and vehicles to drive efficiency, maximise uptime and improve accountability.

By interpreting and reacting to data from over 100 vehicle sensors and the world around it, the Sprinter offers an eye on everything, intuitively supporting drivers while giving a real-time joined up picture of your fleet.

Become part of an elaborate, invisibly connected ecosystem - and keep your business moving.

Proud winners of the following awards...



Contents

› The most adaptable van on the market	4	› Chassis crewcab	25	Keys	41
› Impressive specification	5	Dimensions RWD	26	Lighting	42
› Safety and security	6	Technical data	27	Load-securing	43
› Driver comfort and support	7	Fuel consumption and CO ₂ emissions	28	Load area	44
› Functionality	8	› Dropside	30	Mirrors	44
› Exterior paints & Interior colours and materials	9	Dimensions FWD and RWD	31	Mud flaps	44
› Connectivity	10	Technical data	31	Paint	44
› Mercedes PRO connect	11	Fuel consumption and CO ₂ emissions	32	Parking	45
› Drive options	12	› Equipment	34	Power Take Off	45
› Drive availability across the range	13	Airbags	34	Reversing camera	45
› List prices	14	Alternators	34	Road speed limiters	45
Panel van	14	Audio	34	High Roof	45
Chassis cab	15	Axle	34	Super-high Roof	45
Chassis crewcab	15	Battery	35	Safety and driver assistance	46
› Panel van	16	Brake	35	Security	47
Dimensions FWD	16	Bodywork	36	Seating	47
Dimensions RWD	17	Bulkhead	36	Steering wheel	48
Dimensions AWD	17	Doors	37	Steps	48
Technical data	18	Electronics	37	Suspension	49
Fuel consumption and CO ₂ emissions	19	Exhaust	38	Tacograph	50
› Chassis cab	20	Exterior	38	Towing equipment	51
Dimensions FWD	21	Fuel tank	38	Trim	52
Dimensions RWD	22	Gearbox	38	Tyres	52
Technical data	23	Grab handles	38	Wheels	53
Fuel consumption and CO ₂ emissions	24	Gross Vehicle Weight (GVW)	39	Windows	53
		Heating and ventilation	40	› Keeping Business Moving	54
		Interior storage	41		

Please note

This document provides information about the model range line-up and specifications of the Sprinter. It also contains key details about options, economy and performance of all variants. Details are correct at time of publication and are subject to revision. Any images used in this document may not reflect UK specification and are for illustrative purposes only. Images may show optional equipment which does not form part of UK standard specification.

The most adaptable large van on the market

The Sprinter is 1,700 new vehicles in one – with 6 body styles, 4 power options, 4 body lengths, 3 cargo heights, 3 drive options and dozens of bodybuilder connection points.

For every task, there's a Sprinter.

- **Six body styles** – panel van, crew van, chassis cab, chassis crewcab, Tourer¹ and new Tractor Head for conversion to motorhome.
- **Four common-rail diesel engines** – choose from 4-cylinder (available with 111hp, 143hp or 163hp) or the range topping V6 with 190hp. Sprinter engines¹ reduce in-engine friction and improve fuel consumption.
- **6 speed manual or automatic transmission** across all engine variants – 7G-TRONIC PLUS auto transmission for RWD drives and V6, and 9G-TRONIC for FWD models.
- **Air-suspended rear axle** to protect the most fragile of goods and passengers.

With over 600 items of [standard and optional equipment](#) (go to page 30), including suspension variants and sector-specific solutions for bodybuilders and converters, the Sprinter can be perfectly adapted for any task.

A wide range of styling options.

- Optional high performance LED lighting
- A choice of four different front end options
- Optional light-alloy wheels



Stringent Euro 6/Euro VI emissions standard met

SCR (Selective Catalytic Reduction) technology passes the exhaust gas through a catalytic converter, adding water-based AdBlue[®] to reduce the Sprinter's emissions.

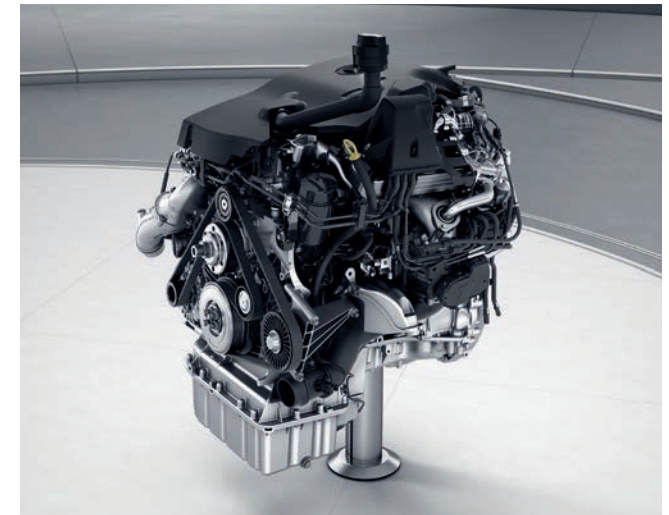

Official government fuel consumption figures in mpg (litres per 100km) for the Mercedes-Benz Sprinter range: Urban 26.9- 36.2, extra urban 31.7- 43.5, combined 29.7-40.4. Combined CO2 emissions: 185-249g/km. The indicated values were determined according to the prescribed measurement method. These are the "NEDC CO2 values" according to Worldwide Harmonised Light Vehicle Test Procedure (WLTP). For more information on these values and how they have been calculated please see www.mbvans.co.uk/WLTP. Official EU-regulated test data are provided for comparison purposes and actual performance will depend on driving style, road conditions, chosen optional extras and other non-technical factors.

Impressive specification.

Class-leading driver support
– as standard.

The Sprinter has a truly impressive and advanced standard specification, helping drivers get the job done safely, efficiently and in typically Mercedes-Benz comfort and style.

- **State-of-the-art MBUX (Mercedes-Benz User Experience) technology** – fitted as standard with:
 - a high resolution 7-inch touchscreen with intuitive touch control and a wealth of infotainment features
 - 'Hey Mercedes', Voice Command Operation*
 - What3words, a geocoded map system offering more accurate location services*
 - a permanent internet connection to the vehicle, which enables Mercedes PRO connect services. For more information about Mercedes PRO connect, see page10
- **Enhanced connectivity** with USB-C and Bluetooth® interface, WiFi hotspot**, Apple CarPlay/Android Auto** and a DAB radio
- **Multifunction steering wheel** – for a streamlined cabin and safe operation while driving
- **Keyless start** – start your vehicle at the push of a button
- **Swift breakdown assistance** at the push of a button: Breakdown Management establishes a data and voice connection to the vehicle and enables fast MoblioVan and Service24h assistance†.

*Standard in conjunction with navigation.

†Can be activated for free as part of Mercedes PRO connect.

** WiFi hotspot requires a separate data contract with Vodafone which can be purchased through the MBUX head unit.



Sixth sense safety and security as standard.

- **Active Brake Assist** warns drivers of oncoming danger and takes over and brakes autonomously if necessary – and critically, recognises and responds to pedestrians
- **Crosswind Assist** detects wind gusts and counteracts them with targeted braking to stabilise your vehicle
- **ADAPTIVE ESP®** reacts to driving conditions that could cause slips or skids by reducing engine power and applying just the right amount of braking to each individual wheel, to stabilise the van
- **ATTENTION ASSIST** detects signs of drowsiness and inattention and instructs drivers to take a break
- **Emergency Call System (eCall)** to connect the van with the emergency services automatically in event of a serious accident
- **Integrated connected alarm system and double lock** offer extra layers of theft protection and alert the driver/vehicle manager by SMS when an alarm is activated
- **Safety monitoring** via Mercedes PRO connect enhances driver safety and business reputation by monitoring acceleration, braking and cornering characteristics. For more information on Mercedes PRO connected features, see page [11](#).

Class-leading optional safety features.

- **Active Lane Keep Assist** to alert drivers when they unintentionally drift or leave their lane, intervening by braking if necessary
- **Active Distance Assist DISTRONIC** allows the driver to set and keep a safe distance from the vehicle ahead – helpful on motorways or stop-start traffic
- **Blind Spot Assist with Rear Cross Traffic Alert** gives visual and audible alerts to help prevent accidents when changing lanes, or reversing
- **Drive Away Assist** – in the event of acceleration towards stationary objects (for example when exiting a parking bay) a warning appears and speed is limited
- **Traffic Sign Assist** recognises both permanent and temporary traffic signs and displays them on your vehicle cluster
- **Highbeam Assist**, automatically detecting oncoming vehicles and dimming full beam at night
- **High performance LED headlights** for maximum visibility of the road ahead
- **Magic Vision Control**, clearing the windscreen without even a moment's disrupted vision.

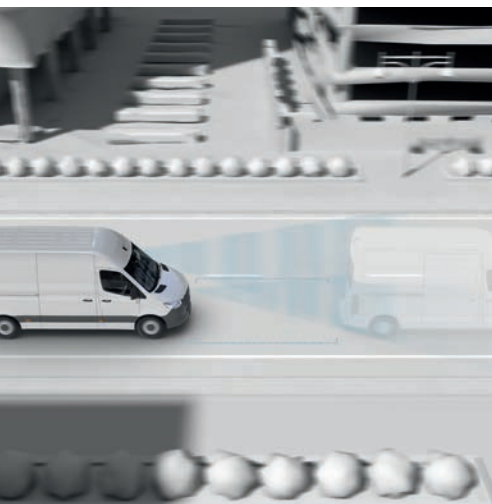

Options for superior driver comfort and support



The MBUX multimedia system with 10.25-inch touchscreen is a fully-integrated navigation system with Live Traffic, VAN-to-X Communication and 3D map display, plus "Hey Mercedes" Voice Command Operation and full smartphone integration, for faster, safer and more relaxed trips.



Conveniently accessible, lockable compartment on the left above the windshield to stow important items securely.



Electrically folding exterior mirrors help when space is tight and are better protected against damage when folded.



Electrically adjustable seats to meet individual comfort requirements at the push of a button. Its highly ergonomic design meets the criteria of the German AGR campaign for healthier backs.



Electric parking brake – simply and conveniently operated via a button.



Reversing Cameras – an optional range of reversing cameras, including 360° for easy parking and manoeuvring.



An auxiliary hot water heater warms the engine coolant and vehicle interior. This makes things easier on the engine and helps to consume less fuel.

Options for hardworking functionality



Internally fitted roof racks are available to protect items against theft and prevent the need for external racking to be mounted.



Ply-lining on the wheel arches and van walls from factory makes loading easier and protects the metal panelling from damage.



Two LED light strips under the roof illuminate the load compartment, for improved visibility inside when loading and unloading the vehicle.



Pallet support in the step of the sliding door stabilises loads in the door area and is particularly useful when transporting Europallets or crates.



Several side load securing options enable you to secure your vehicle's cargo safely and professionally – these include a lashing rail system, various types of partition, a side wall anchoring system, and restraint belts and ratchet belts.



Multifunction box provides drivers and co-drivers with a practical workspace to attend to paperwork in the cockpit – and an integrated tablet holder is also available¹. When not in use, this box can be stored in the storage area beneath the dual passenger seats.

¹ Tablet holder available from Mercedes-Benz Accessories only.

Exterior paints & Interior colours and materials

The new standard and metallic paint portfolio is shown below. The paints are available for all type variants:

Standard Paints



MB 3589 Jupiter Red

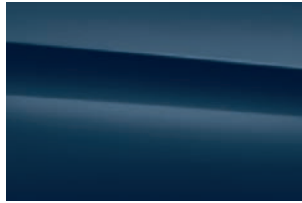

MB 5389 Steel Blue

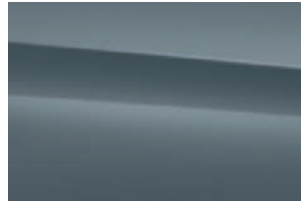

MB 7709 Blue Grey

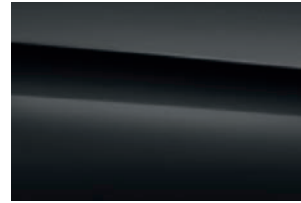

MB 9040 Jet Black



MB 9147 Artic White

Metallic paints

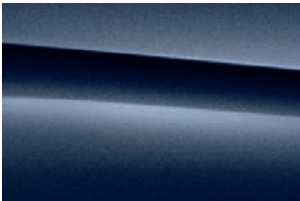

MB 5890 Cavansite Blue Metallic

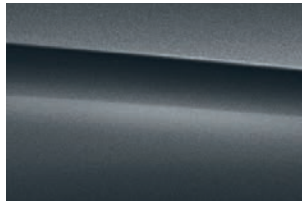

MB 7755 Tenorite Grey Metallic

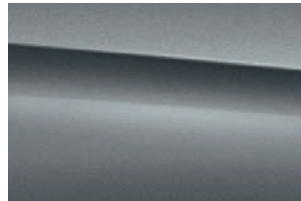

MB 7992 Selenite Grey Metallic

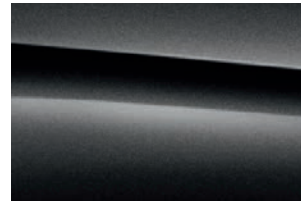

MB 9197 Obsidian Black Metallic



MB 9775 Iridium Silver Metallic

Interior colours and material

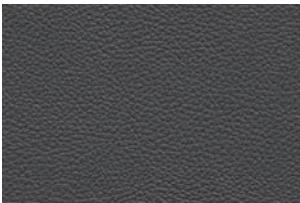

VF6 Black ARTICO man-made leather

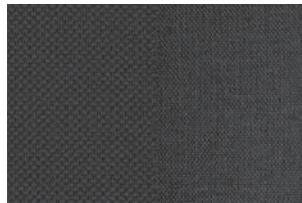

VF7 Maturin black fabric

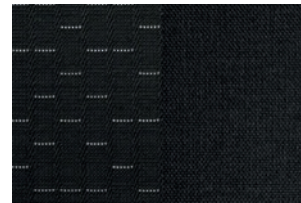

VF4 Caluma black fabric

For a full range of optional paints, speak to your local dealer.

Connectivity.

The first van to intelligently connect businesses and vehicles instantly to maximise efficiency.

Future-proof your business with connected technologies.

The Sprinter is the first van on the market with its own fully integrated telematics solution – included for free*. Mercedes PRO connect gives businesses of all sizes a cost-effective way to intelligently connect with their vehicles – in real time. It's an intelligent vehicle monitoring and communication system that helps improve accountability, drive efficiency and seamlessly keep your business moving.

Combining advanced onboard hardware, an integrated SIM-card and innovative software services, Mercedes PRO connect is designed to grow with the possibilities of connected technologies. Scalable and future-proof, the software is updated every 6 months, providing further innovative services.

One day, all Mercedes-Benz vans will be like this and in late 2019, Mercedes PRO connect will be compatible with models from other brands too.†

***With the Sprinter, we offer a range of connected vehicle services free of charge.**

These include: MB Emergency Call System (eCall), Maintenance Management, Accident and Breakdown Management, Fleet Communication, Internet in the van and Digital Trip Management. We also offer a range of extended services, which are offered free of charge, for three years. These extended services include: Vehicle Supervision, Vehicle Operations, Theft Warning, Eco Monitor and Safety Monitor. Safety Monitor is available from Q1 2019.

Additional premium services are also available to purchase via our Mercedes PRO eStore, including: Remote Services and Digital Driver's log. The service 'Internet in the van' which acts as a WiFi hotspot requires a separate data contract with Vodafone. Navigation Services are offered free of charge in conjunction with factory-fitted MBUX Navigation (E1E), for three years.

† Planned for August 2019

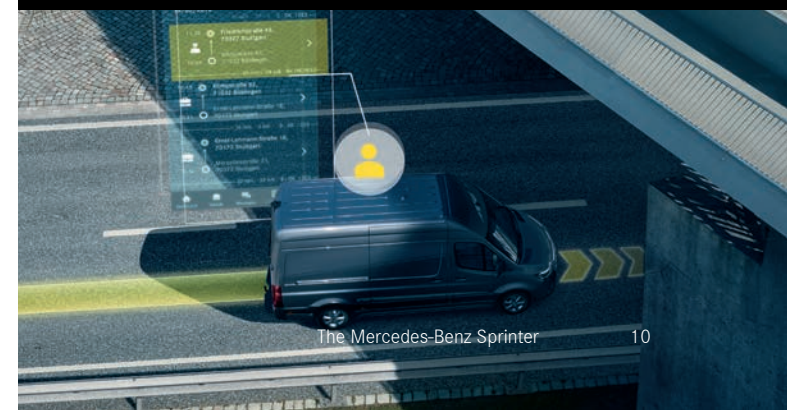
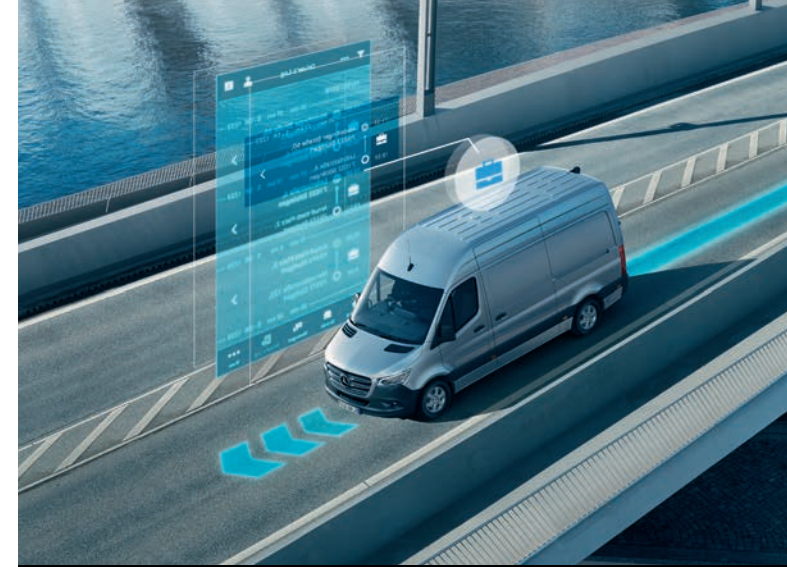

Mercedes PRO connect

Enjoy a complete overview of everything available with Mercedes PRO connect for drivers and managers.



Simplified Fleet Communications -

Plan and manage assignments online and communicate them directly to drivers, improving productivity.



Optimised Assistance - Improve safety and reduce unexpected downtime. Optimised Assistance helps manage maintenance and repairs, gives alerts in safety critical situations such as low brake fluid and despatches roadside assistance to drivers in need.



Efficient Fleet Management - Offers a joined-up picture of your fleet at any given time, with a real-time overview of each vehicle's status, location, fuel levels and more, to allow for better planning and more responsive deployment of vehicles.



Efficient Driving Style Analysis - Reduce fuel consumption and increase safety - data on each user's driving style gives actionable insights to optimise fuel efficiency and safety.



Improved Navigation† - Get there faster and more efficiently with navigation that draws data from multiple sources including other vans, to give drivers the very best route.



Digital Records - Save time and enjoy complete visibility over vehicle use - Digital Records show data from all completed trips, saving time when it comes to record-keeping, helping to optimise regular trips, and separating business and personal use.



Mobile Vehicle Access* - Control each van from anywhere in the world - drivers can operate certain functions of the vehicle remotely and give multiple users keyless access to the same vehicle. They can even pre-heat the vehicle prior to accessing.



Send-2-Van† - Communicate the next job to your driver by sending navigation data directly to the MBUX head unit of your new Sprinter. Mercedes PRO connect thereby enables efficient job dispatching and with Live Traffic, works out the most efficient, safest route.

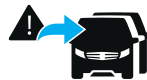

Van-to-X Communication† - Increases the safety of your drivers and other road users. The new Sprinter intelligently drops and receives warnings wherever a hazard is detected - such as a slippery road or broken down vehicle. It also receives other warnings from external sources like convoys, emergency vehicles or roadworks.

Additional features available with navigation:*

- Van-to-X Communication
[Watch our explanation film](#)
or visit <https://bit.ly/20Wiun1>
- Live Traffic Information
- Online Map Update
- 'Hey Mercedes' Voice Command Operation
- Weather Information
- Petrol Station Prices
- TuneIn Internet Radio
- Local Search
- Find any point of interest, from coffee shops to depots
- Available Parking Spaces

For more information on Mercedes PRO connect, [download our brochure](#) or visit <https://bit.ly/2yQX6s9>

*Pre-heat function available in conjunction with 'Auxiliary Hot Water Heater' option (see p36). **Function available in conjunction with 'Auxiliary Hot Water Heater' option (see p36).

†Navigation Services are offered free of charge in conjunction with factory-fitted MBUX Navigation (E1E), for three years. WiFi hotspot requires a separate data contract with

Vodafone which can be purchased through the MBUX head unit.

WiFi hotspot requires a separate data contract with Vodafone which can be purchased through the MBUX head unit.

Drive options.

Over the next few pages, we've listed the technical data for the various drivetrains available in the Sprinter – including Front-wheel drive (FWD), Rear-wheel drive (RWD) and All-wheel drive (AWD).

There are advantages to each of the drivetrains, depending on your business's requirements. For example, FWD delivers improved traction when carrying lighter loads, a larger load compartment volume, and a higher payload capacity. It also exclusively offers the new 9G-TRONIC automatic transmission.

With RWD, the separation of the drive system and steering optimises the turning circle for more agile handling – particularly with the higher-powered 120 kW2 and 140 kW3 engines. And the drive system at the rear axle comes into its own when towing a trailer.

Finally, with AWD you can benefit from a manually selectable 4x4 all-wheel drive system that improves traction in difficult driving conditions.

Key features



Front-wheel drive (FWD):

- Better for multi drop deliveries due to low entry rear step and the omission of a side step
- Lower loading sill – makes it easier to load and unload, helping to make multiple trips and stops more efficient
- Improved fuel economy and payload.



Rear-wheel drive (RWD):

- Can tow up to 3.5t
- Offers the widest variety of engine sizes.

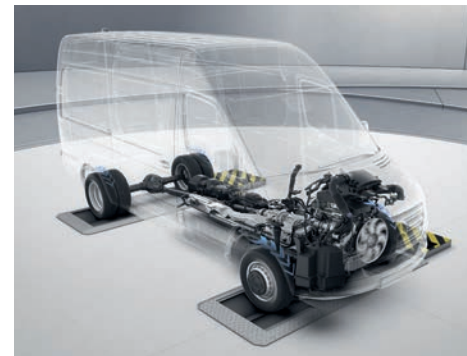

All-wheel drive (AWD):

- Manually selectable 4x4 to suit the environment you're in
- Reliable and safe on slippery surfaces, steep declines and difficult driving conditions
- Minimum weight impact – get more traction without sacrificing payload or efficiency



Introducing new naming conventions

Sprinter (pre-2017)	Sprinter (2019)
Short	L1
Medium	L2
Long	L3
Extra-long	L4
Standard roof	H1
High roof	H2
Super-high roof	H3

Additionally, the introduction of FWD, RWD and AWD will appear in the description:

FWD = Front-wheel drive

RWD = Rear-wheel drive

AWD = All-wheel drive

Drive availability across the Sprinter range

	Panel van		Chassis		Chassis crewcab		Dropside	
	FWD	RWD	FWD	RWD	FWD	RWD	FWD	RWD
L1 (short)								
211 CDi	•		•					
214 CDi	•		•					
311 CDi	•		•					
314 CDi	•		•					
411 CDi	•		•					
414 CDi	•		•					
L2 (medium)								
211 Cdi	•		•					
214 CDi	•		•					
311 CDi	•	•	•	•		•	•	•
314 CDi	•	•	•	•		•	•	•
316 CDi		•		•		•		•
319 CDi		•		•		•		•
411 CDi	•		•					
414 CDi	•	•	•					
416 CDi		•						
419 CDi		•						
514 CDi		•		•		•		•
516 CDi		•		•		•		•
519 CDi		•		•		•		•
L3 (long)								
311 CDi		•		•		•		•
314 CDi		•		•		•		•
316 CDi		•		•		•		•
319 CDi		•		•				•
414 CDi		•						
416 CDi		•						
514 CDi		•		•		•		•
516 CDi		•		•		•		•
519 CDi		•		•		•		•
L4 (extra long)								
311 CDi		•						
314 CDi		•						
316 CDi		•						
319 CDi		•						
414 CDi		•						
416 CDi		•						
514 CDi		•						
516 CDi		•						
519 CDi		•						

List prices – Sprinter panel van*

Model/bodystyle	H1 - FWD		H1 - RWD		H2 - RWD		H2 - AWD	
	L1	L2	L1	L2	L3	L4	L2	L3
211CDI 3.0t	£25,330	£26,850	-	-	-	-		
214CDI 3.0t	£25,750	£27,270	-	-	-	-		
311CDI 3.5t	£29,690	£31,200	-	£32,480	£34,370	£35,070		
314CDI 3.5t	£30,110	£31,630	-	£32,910	£34,790	£35,490		
316CDI 3.5t	-	-	-	£33,540	£35,430	£36,130	£39,235	£41,045
319CDI 3.5t	-	-	-	£36,830	£38,710	£39,420	£43,925	£45,735
411CDI 4.1t	£31,130	£32,650	-	-	-	-		
414CDI 4.1t	£31,550	£33,070	-	£34,350	£36,230	£36,940		
416CDI 4.1t	-	-	-	£34,990	£36,870	£37,570		
514CDI 5.0t	-	-	-	£39,540	£41,420	£42,120		
516CDI 5.0t	-	-	-	£40,180	£42,060	£42,760	£45,550	£47,360
519CDI 5.0t	-	-	-	£43,470	£45,350	£46,050	£50,240	£52,050

*List prices are quoted ex-factory and exclude VAT unless otherwise stated. A standard delivery charge of £600 excluding VAT will be added to model prices quoted in this price list. All model prices include standard finish paint choice. The right is reserved to alter specification and vary prices without notice. The availability of options may depend on the chosen base vehicle and other optional equipment specified, and should be confirmed with your Mercedes-Benz Dealer prior to order placement. Mercedes-Benz Vans UK Ltd, Tongwell, Milton Keynes, MK15 8BA.

List prices – Sprinter chassis cab*

Model/bodystyle	FWD		RWD			AWD	
	L1	L2	L1	L2	L3	L2	L3
211CDI 3.0t	£24,680	£25,410	-	-	-	-	-
214CDI 3.0t	£25,110	£25,830	-	-	-	-	-
311CDI 3.5t	£29,350	£30,080	-	£31,360	£32,090	-	-
314CDI 3.5t	£29,770	£30,500	-	£31,780	£32,510	-	-
316CDI 3.5t	-	-	-	£32,420	£33,150	£38,155	£38,855
319CDI 3.5t	-	-	-	£35,710	£36,440	£42,845	£43,545
514CDI 5.0t	-	-	-	£38,430	£39,160		
516CDI 5.0t	-	-	-	£39,070	£39,800	£44,485	£45,185
519CDI 5.0t	-	-	-	£42,360	£43,090	£49,175	£49,875

List prices – Sprinter chassis crewcab*

Model/bodystyle	RWD			AWD	
	L1	L2	L3	L2	L3
311CDI 3.5t	£33,080	£33,800	£34,530	-	-
314CDI 3.5t	£33,500	£34,230	£34,950	-	-
316CDI 3.5t	£34,140	£34,870	£35,590	-	-
319CDI 3.5t	-	£38,150	£38,880	-	-
514CDI 5.0t	-	£40,880	£41,600	-	-
516CDI 5.0t	-	£41,520	£42,240	£46,835	£47,535
519CDI 5.0t	-	£44,800	£45,530	£51,525	£52,225

For Dropside and Crew van pricing, please combine your preferred chassis price with the price of the relevant Dropside or Crew van body, listed on page [32](#).

*List prices are quoted ex-factory and exclude VAT unless otherwise stated. A standard delivery charge of £600 excluding VAT will be added to model prices quoted in this price list. All model prices include standard finish paint choice. The right is reserved to alter specification and vary prices without notice. The availability of options may depend on the chosen base vehicle and other optional equipment specified, and should be confirmed with your Mercedes-Benz Dealer prior to order placement. Mercedes-Benz Vans UK Ltd, Tongwell, Milton Keynes, MK15 8BA.

Dimensions - Panel van (FWD)

Panel van L1 H1 FWD

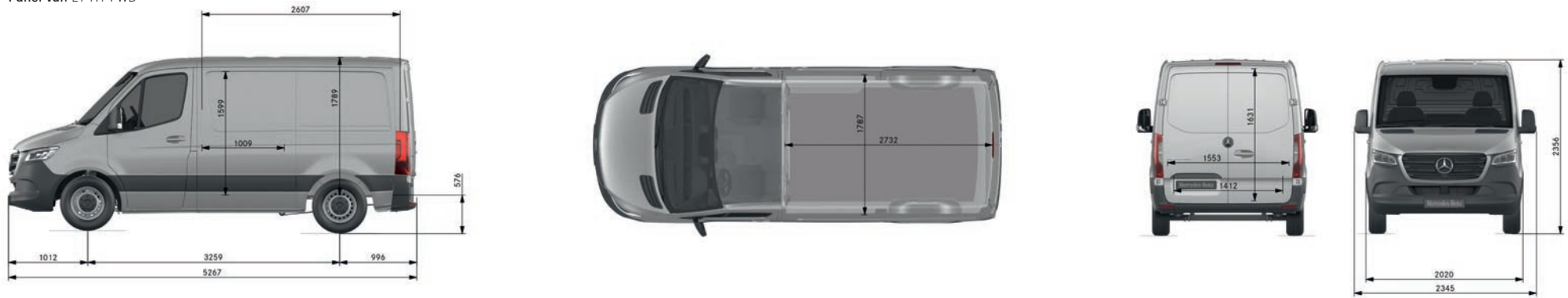

Panel van L2 H1 FWD

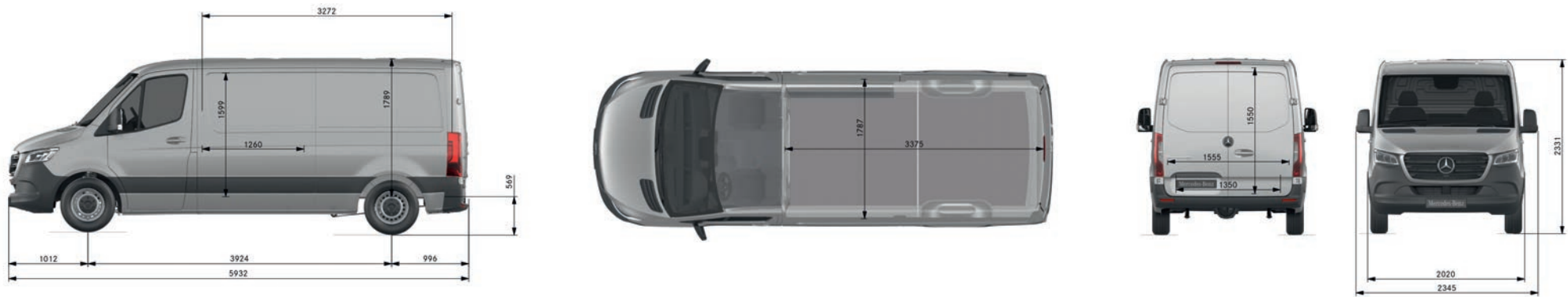

Please note: The stated vehicle dimensions and payload weights are correct according to type approval data. The specific payload values for UK supplied vehicles may differ. The figure quoted does not account for equipment which is included in the UK product offer as standard.

Dimensions - Panel van (RWD)

Panel van L2 H1 RWD

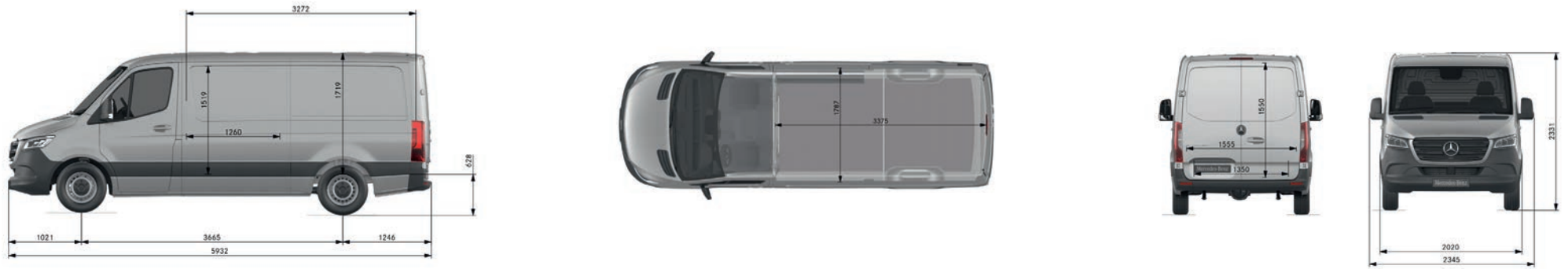

Panel van L3 H2 RWD

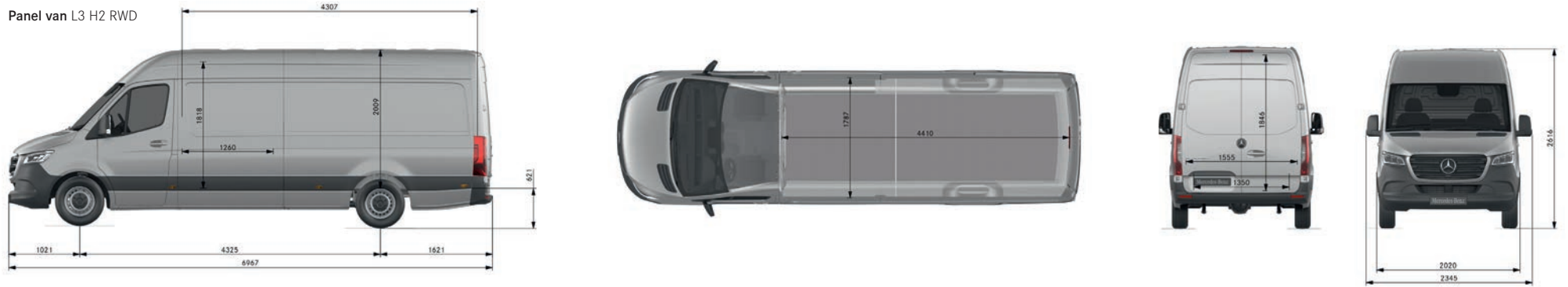

Panel van L4 H2 RWD

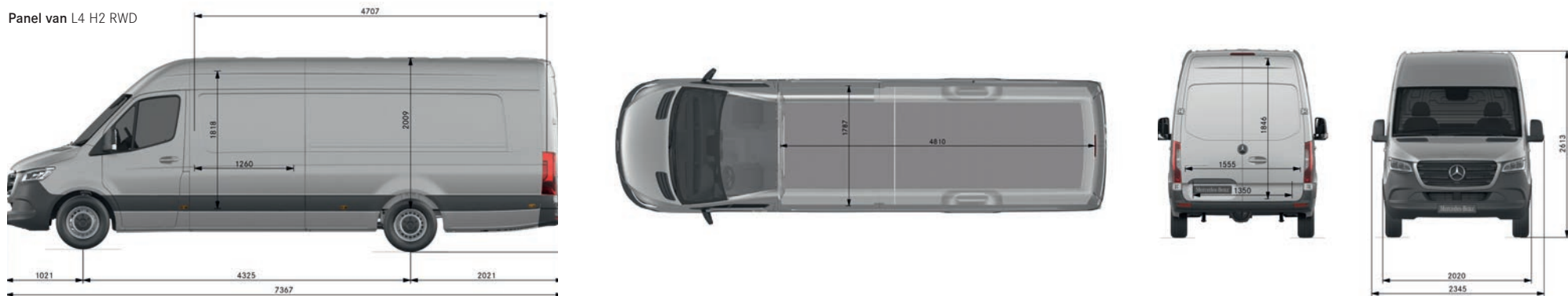

Please note: The stated vehicle dimensions and payload weights are correct according to type approval data. The specific payload values for UK supplied vehicles may differ. The figure quoted does not account for equipment which is included in the UK product offer as standard.

Technical data - Panel van

	Perm GVW (t)	Fuel	Engine output	Emission standard	Torque	Kerb weight ^{3,4} , kg	Payload ⁵ , kg	Perm Gross Combination Weight, kg	Max. roof load, kg	Cargo area, m ² Cargo volume, m ³ Max. loading length, mm	Turning circle Ø, m Track circle Ø, m			
L1														
211 CDI FWD	3.0	Diesel ¹	114 hp (84 kW) at 3800 rpm 4 cylinders 2143 cc	Euro 6b Gr. III/Euro VI ²	300 Nm at 1200-2200 rpm	2113	887	5000	300	4.357m ² 7.8m ³ 2607mm	13-13.4 12.2-12.6			
214 CDI FWD	3.0	Diesel ¹	143 hp (100 kW) at 3800 rpm 4 cylinders 2143 cc	Euro 6b Gr. III/Euro VI ²	330 Nm at 1200-2400 rpm	2113	887	5000						
311 CDI FWD	3.5	Diesel ¹	114 hp (84 kW) at 3800 rpm 4 cylinders 2143 cc	Euro 6b Gr. III/Euro VI ²	300 Nm at 1200-2200 rpm	2113	1387	5500						
314 CDI FWD	3.5	Diesel ¹	143 hp (100 kW) at 3800 rpm 4 cylinders 2143 cc	Euro 6b Gr. III/Euro VI ²	330 Nm at 1200-2400 rpm	2113	1387	5500						
411 CDI FWD	4.1	Diesel ¹	114 hp (84 kW) at 3800 rpm 4 cylinders 2143 cc	Euro 6b Gr. III/Euro VI ²	300 Nm at 1200-2200 rpm	2138	1962	6100						
414 CDI FWD	4.1	Diesel ¹	143 hp (100 kW) at 3800 rpm 4 cylinders 2143 cc	Euro 6b Gr. III/Euro VI ²	330 Nm at 1200-2400 rpm	2138	1962	6100						
L2														
211 CDI FWD	3.0	Diesel ¹	114 hp (84 kW) at 3800 rpm 4 cylinders 2143 cc	Euro 6b Gr. III/Euro VI ²	300 Nm at 1400-2400 rpm	2196	804	5000	300	5.08-5.539m ² 9-9.5m ³ 3272mm	13.2-15.7 12.3-14.9			
214 CDI FWD	3.0	Diesel ¹	143 hp (100 kW) at 3800 rpm 4 cylinders 2143 cc	Euro 6b Gr. III/Euro VI ²	330 Nm at 1200-2400 rpm	2196	804	5000						
311 CDI FWD	3.5	Diesel ¹	114 hp (84 kW) at 3800 rpm 4 cylinders 2143 cc	Euro 6b Gr. III/Euro VI ²	300 Nm at 1400-2400 rpm	2196	1304	5500						
314 CDI FWD	3.5	Diesel ¹	143 hp (100 kW) at 3800 rpm 4 cylinders 2143 cc	Euro 6b Gr. III/Euro VI ²	330 Nm at 1200-2400 rpm	2196	1304	5500						
311 CDI RWD	3.5	Diesel ¹	114 hp (84 kW) at 3800 rpm 4 cylinders 2143 cc	Euro 6b Gr. III/Euro VI ²	300 Nm at 1400-2400 rpm	2236-2300	1200-1264	5500						
314 CDI RWD	3.5	Diesel ¹	143 hp (100 kW) at 3800 rpm 4 cylinders 2143 cc	Euro 6b Gr. III/Euro VI ²	330 Nm at 1200-2400 rpm	2236-2300	1200-1264	5500						
316 CDI RWD	3.5	Diesel ¹	163 hp (120 kW) at 3800 rpm 4 cylinders 2143 cc	Euro 6b Gr. III/Euro VI ²	360 Nm at 1400-2400 rpm	2236-2300	1200-1264	5500						
319 CDI RWD	3.5	Diesel ¹	190 hp (140 kW) at 3800 rpm 6 cylinders/V 72° 2987 cc	Euro VI	440 Nm at 1400-2400 rpm	2236-2300	1200-1264	5500						
411 CDI FWD	4.1	Diesel ¹	114 hp (84 kW) at 3800 rpm 4 cylinders 2143 cc	Euro 6b Gr. III/Euro VI ²	300 Nm at 1400-2400 rpm	2222	1878	6100						
414 CDI FWD	4.1	Diesel ¹	143 hp (100 kW) at 3800 rpm 4 cylinders 2143 cc	Euro 6b Gr. III/Euro VI ²	330 Nm at 1200-2400 rpm	2222	1878	6100						
414 CDI RWD	4.1	Diesel ¹	143 hp (100 kW) at 3800 rpm 4 cylinders 2143 cc	Euro 6b Gr. III/Euro VI ²	330 Nm at 1200-2400 rpm	2236-2278	1822-1864	6100						
416 CDI RWD	4.1	Diesel ¹	163 hp (120 kW) at 3800 rpm 4 cylinders 2143 cc	Euro 6b Gr. III/Euro VI ²	360 Nm at 1400-2400 rpm	2236-2278	1822-1864	6100						
419 CDI RWD	4.1	Diesel ¹	190 hp (140 kW) at 3800 rpm 6 cylinders/V 72° 2987 cc	Euro VI	440 Nm at 1400-2400 rpm	2236-2278	1822-1864	6100						
514 CDI RWD	5.0	Diesel ¹	143 hp (100 kW) at 3800 rpm 4 cylinders 2143 cc	Euro 6b Gr. III/Euro VI ²	330 Nm at 1200-2400 rpm	2453-2495	2505-2547	7000						
516 CDI RWD	5.0	Diesel ¹	163 hp (120 kW) at 3800 rpm 4 cylinders 2143 cc	Euro 6b Gr. III/Euro VI ²	360 Nm at 1400-2400 rpm	2453-2495	2505-2547	7000						
519 CDI RWD	5.0	Diesel ¹	190 hp (140 kW) at 3800 rpm 6 cylinders/V 72° 2987 cc	Euro VI	440 Nm at 1400-2400 rpm	2453-2495	2505-2547	7000						
L3														
311 CDI RWD	3.5	Diesel ¹	114 hp (84 kW) at 3800 rpm 4 cylinders 2143 cc	Euro 6b Gr. III/Euro VI ²	300 Nm at 1400-2400 rpm	2422-2486	1014-1078	5500				150	6.9m ² 14m ³ 4307mm	15.2-16.1 14.3-15.3
314 CDI RWD	3.5	Diesel ¹	143 hp (100 kW) at 3800 rpm 4 cylinders 2143 cc	Euro 6b Gr. III/Euro VI ²	330 Nm at 1200-2400 rpm	2422-2486	1014-1078	5500						
316 CDI RWD	3.5	Diesel ¹	163 hp (120 kW) at 3800 rpm 4 cylinders 2143 cc	Euro 6b Gr. III/Euro VI ²	360 Nm at 1400-2400 rpm	2422-2486	1014-1078	5500						
319 CDI RWD	3.5	Diesel ¹	190 hp (140 kW) at 3800 rpm 6 cylinders/V 72° 2987 cc	Euro VI	440 Nm at 1400-2400 rpm	2422-2486	1014-1078	5500						
414 CDI RWD	4.1	Diesel ¹	143 hp (100 kW) at 3800 rpm 4 cylinders 2143 cc	Euro 6b Gr. III/Euro VI ²	330 Nm at 1200-2400 rpm	2422	1678	6100						
416 CDI RWD	4.1	Diesel ¹	163 hp (120 kW) at 3800 rpm 4 cylinders 2143 cc	Euro 6b Gr. III/Euro VI ²	360 Nm at 1400-2400 rpm	2422	1678	6100						
514 CDI RWD	5.0	Diesel ¹	143 hp (100 kW) at 3800 rpm 4 cylinders 2143 cc	Euro 6b Gr. III/Euro VI ²	330 Nm at 1200-2400 rpm	2652-2694	2306-2343	7000						
516 CDI RWD	5.0	Diesel ¹	163 hp (120 kW) at 3800 rpm 4 cylinders 2143 cc	Euro 6b Gr. III/Euro VI ²	360 Nm at 1400-2400 rpm	2652-2694	2306-2343	7000						
519 CDI RWD	5.0	Diesel ¹	190 hp (140 kW) at 3800 rpm 6 cylinders/V 72° 2987 cc	Euro VI	440 Nm at 1400-2400 rpm	2652-2694	2306-2343	7000						
L4														
311 CDI RWD	3.5	Diesel ¹	114 hp (84 kW) at 3800 rpm 4 cylinders 2143 cc	Euro 6b Gr. III/Euro VI ²	300 Nm at 1400-2400 rpm	TBC		5500	150	7.606m ² 15.5m ³ 4707mm	15.2-16.1 14.3-15.3			
314 CDI RWD	3.5	Diesel ¹	143 hp (100 kW) at 3800 rpm 4 cylinders 2143 cc	Euro 6b Gr. III/Euro VI ²	330 Nm at 1200-2400 rpm			5500						
316 CDI RWD	3.5	Diesel ¹	163 hp (120 kW) at 3800 rpm 4 cylinders 2143 cc	Euro 6b Gr. III/Euro VI ²	360 Nm at 1400-2400 rpm			5500						
319 CDI RWD	3.5	Diesel ¹	190 hp (140 kW) at 3800 rpm 6 cylinders/V 72° 2987 cc	Euro VI	440 Nm at 1400-2400 rpm			5500						
414 CDI RWD	4.1	Diesel ¹	143 hp (100 kW) at 3800 rpm 4 cylinders 2143 cc	Euro 6b Gr. III/Euro VI ²	330 Nm at 1200-2400 rpm			6100						
416 CDI RWD	4.1	Diesel ¹	163 hp (120 kW) at 3800 rpm 4 cylinders 2143 cc	Euro 6b Gr. III/Euro VI ²	360 Nm at 1400-2400 rpm			6100						
514 CDI RWD	5.0	Diesel ¹	143 hp (100 kW) at 3800 rpm 4 cylinders 2143 cc	Euro 6b Gr. III/Euro VI ²	330 Nm at 1200-2400 rpm			7000						
516 CDI RWD	5.0	Diesel ¹	163 hp (120 kW) at 3800 rpm 4 cylinders 2143 cc	Euro 6b Gr. III/Euro VI ²	360 Nm at 1400-2400 rpm			7000						
519 CDI RWD	5.0	Diesel ¹	190 hp (140 kW) at 3800 rpm 6 cylinders/V 72° 2987 cc	Euro VI	440 Nm at 1400-2400 rpm			7000						

¹Diesel particulate filter is standard equipment for all diesel engines. ²Euro VI is possible for a reference mass of 2380 kg or higher. Euro VI is added automatically for a reference mass of 2840 kg or higher and added with certain options. ³Figures according to Directive 97/27/EC, version applicable at the time of going to press: Mass of the vehicle in running order means the mass of the unladen vehicle with bodywork, and with coupling device in the case of a towing vehicle, in running order, or the mass of the chassis with cab if the manufacturer does not fit the bodywork and/or coupling device. (including coolant, oils, 90% fuel, 100% other liquids except used waters, tools, spare wheel and driver (75 kg), and, for buses and coaches, the mass of the crew member (75 kg) if there is a crew seat in the vehicle). ⁴For vehicles with all-wheel drive, kerb weight is increased by approx. 130-165 kg. ⁵For vehicles with all-wheel drive, payload decreases by approx. 130-165 kg. ⁶Increased permissible GCW in conjunction with reinforced trailer coupling as optional equipment.

Information in accordance with Regulation (EU) 1230/2012 in the version valid at the time of printing. (With driver 75 kg, all operating fluids and 90% tank filling.) For further information please contact your Mercedes-Benz sales representative. Original accessories can have relevant vehicle characteristics such as weight, rolling and air resistance, and have an influence on the values of consumption and driving performance in addition to traffic and weather conditions.

Fuel consumption and CO₂ emissions - Panel van

Please speak to your local Dealer for further information.

FWD Engine	Transmission	CO ₂ emissions combined [g/km]	Fuel economy, urban, mpg	Fuel economy, extra-urban, mpg	Fuel economy, combined, mpg
211CDI L1	6-speed manual	208	30.1	38.7	35.8
	9-speed automatic	216	32.8	34.9	34.4
211CDI L2	6-speed manual	213	29.7	37.7	34.9
	9-speed automatic	219	32.5	34.4	34.0
214CDI L1	6-speed manual	208	30.1	38.7	35.8
	9-speed automatic	216	32.8	34.9	34.4
214CDI L2	6-speed manual	213	29.7	37.7	34.9
	9-speed automatic	219	32.5	34.4	34.0
311CDI L1	6-speed manual	208	30.1	38.7	35.8
	9-speed automatic	216	32.8	34.9	34.4
311CDI L2	6-speed manual	213	29.7	37.7	34.9
	9-speed automatic	219	32.5	34.4	34.0
314CDI L1	6-speed manual	208	30.1	38.7	35.8
	9-speed automatic	216	32.8	34.9	34.4
314CDI L2	6-speed manual	213	29.7	37.7	34.9
	9-speed automatic	219	32.5	34.4	34.0
411CDI L1	6-speed manual	208	30.1	38.7	35.8
	9-speed automatic	216	32.8	34.9	34.4
411CDI L2	6-speed manual	213	29.7	37.7	34.9
	9-speed automatic	219	32.5	34.4	34.0
414CDI L1	6-speed manual	208	30.1	38.7	35.8
	9-speed automatic	216	32.8	34.9	34.4
414CDI L2	6-speed manual	213	29.7	37.7	34.9
	9-speed automatic	219	32.5	34.4	34.0

RWD Engine	Transmission	Rear axle ratio	CO ₂ emissions [g/km]	Fuel economy, urban, mpg	Fuel economy, extra-urban, mpg	Fuel economy, combined, mpg
311CDI L2	6-speed manual	4,182	217	29.4	38.2	34.0
	7-speed automatic	4,182	215	34.0	35.8	34.4
311CDI L3	6-speed manual	4,182	219	28.5	37.2	33.6
	7-speed automatic	4,182	217	33.6	35.3	34.0
314CDI L2	6-speed manual	3,923	207	31.7	38.7	35.8
	7-speed automatic	3,923	211	32.8	36.7	35.3
314CDI L3	6-speed manual	3,923	210	31.4	37.7	35.3
	7-speed automatic	3,923	213	32.1	36.2	34.9
316CDI L2	6-speed manual	3,923	207	31.7	38.7	35.8
	7-speed automatic	3,692	203	34.9	37.2	36.2
316CDI L3	6-speed manual	3,923	210	31.4	37.7	35.3
	7-speed automatic	3,692	207	34.4	36.7	35.8
319CDI L2	7-speed automatic	3,692	249	26.9	31.7	29.7
319CDI L3	7-speed automatic	3,692	249	26.9	31.7	29.7
414CDI L2	6-speed manual	4,182	217	29.4	38.2	34.0
	7-speed automatic	3,923	211	32.8	36.7	35.3
414CDI L3	6-speed manual	4,182	219	28.5	37.2	33.6
	7-speed automatic	3,923	213	32.1	36.2	34.9
416CDI L2	6-speed manual	3,923	207	31.7	38.7	35.8
	7-speed automatic	3,692	203	34.9	37.2	36.2
416CDI L3	6-speed manual	3,923	210	31.4	37.7	35.3
	7-speed automatic	3,692	207	34.4	36.7	35.8
419CDI L2	7-speed automatic	3,692	249	26.9	31.7	29.7
514CDI L2	6-speed manual	4,727	185	36.2	43.5	40.4
	7-speed automatic	4,182	205	29.7	41.5	36.2
514CDI L3	6-speed manual	4,727	188	35.8	42.8	39.8
	7-speed automatic	4,182	208	29.4	40.9	35.8
516CDI L2	6-speed manual	4,182	199	30.7	42.8	37.2
	7-speed automatic	4,182	205	29.7	41.5	36.2
516CDI L3	6-speed manual	4,182	202	30.4	42.2	36.7
	7-speed automatic	4,182	208	29.4	40.9	35.8
519CDI L2	7-speed automatic	3,692	249	26.9	31.7	29.7
519CDI L3	7-speed automatic	3,692	249	26.9	31.7	29.7

The stated values have been determined according to the respective measuring method (according to Regulation (EC) No 715/2007, as amended). Note: The information does not refer to a single vehicle and is not part of the offer, but serves solely for purposes of comparison between the different vehicle types. CO₂ emissions resulting from the production and supply of fuel or other energy sources are not taken into account when CO₂ emissions are determined in accordance with Directive 1999/94 / EC.

Fuel consumption and CO₂ emissions - Panel van

AWD Engine	Transmission	Rear axle ratio	CO ₂ emissions [g/km]	Fuel economy, urban, mpg	Fuel economy, extra-urban, mpg	Fuel economy, combined, mpg
316CDI L2	6-speed manual	4,182	226	27.4	37.1	32.8
	7-speed automatic	3,923	235	27.6	34.4	31.7
316CDI L3	6-speed manual	4,182	230	27.1	36.6	32.4
	7-speed automatic	3,923	238	27.4	34.0	31.3
319CDI L2	7-speed automatic	3,923	258	24.7	32.1	28.8
319CDI L3	7-speed automatic	3,923	261	24.5	31.7	28.5
516CDI L2	6-speed manual	TBC	TBC	TBC	TBC	TBC
	7-speed automatic	TBC	TBC	TBC	TBC	TBC
516CDI L3	6-speed manual	TBC	TBC	TBC	TBC	TBC
	7-speed automatic	TBC	TBC	TBC	TBC	TBC
519CDI L2	7-speed automatic	TBC	TBC	TBC	TBC	TBC
519CDI L3	7-speed automatic	TBC	TBC	TBC	TBC	TBC

The stated values have been determined according to the respective measuring method (according to Regulation (EC) No 715/2007, as amended). Note: The information does not refer to a single vehicle and is not part of the offer, but serves solely for purposes of comparison between the different vehicle types. CO₂ emissions resulting from the production and supply of fuel or other energy sources are not taken into account when CO₂ emissions are determined in accordance with Directive 1999/94 / EC.

Dimensions - Chassis cab (FWD)

Chassis cab L1 FWD

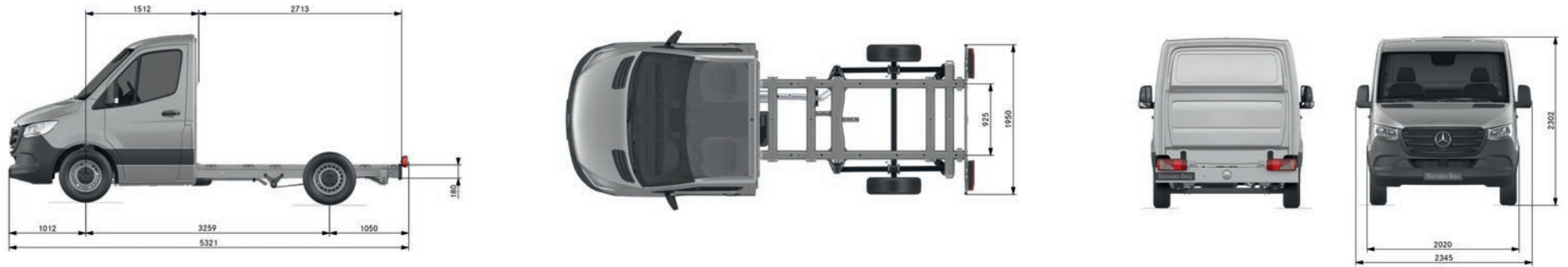

Chassis cab L2 FWD



Dimensions - Chassis cab (RWD)

Chassis cab L2 RWD

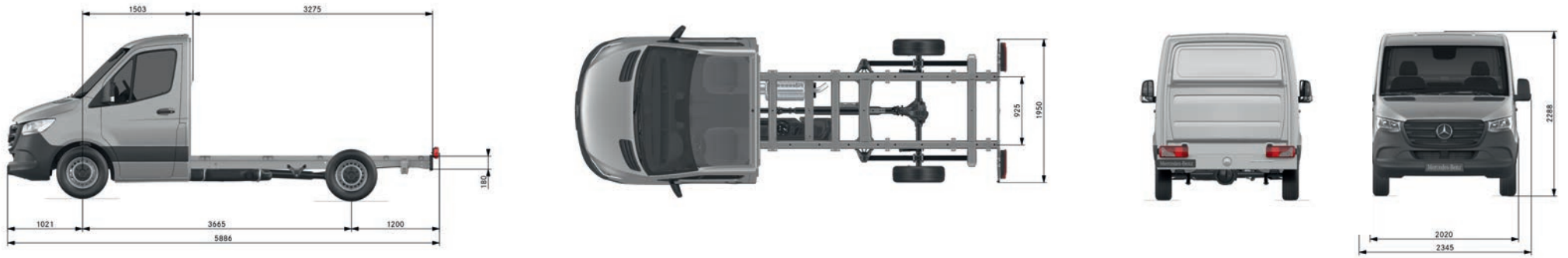

Chassis cab L3 RWD

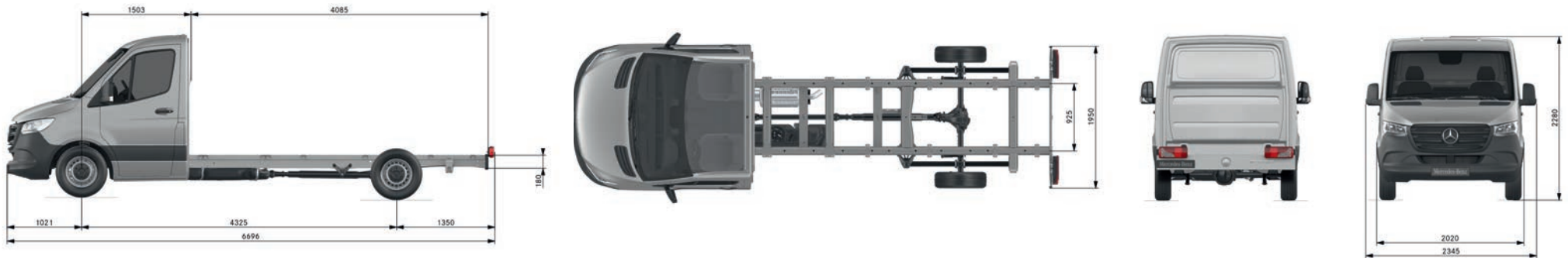

Technical data - Chassis cab

These figures are for the Chassis cab base vehicle only. The figures will change once body work is fitted.

	Perm GVW (t)	Fuel	Engine output	Emission standard	Torque	Kerb weight ^{3,4} , kg (Pre-body fitting data only)	Payload ⁵ , kg (Pre-body fitting data only)	Perm Gross Combination Weight, kg	Turning circle Ø, m Track circle Ø, m
L1									
211 CDi FWD	3.0	Diesel ¹	114 hp (84 kW) at 3800 rpm 4 cylinders 2143 cc	Euro 6b Gr. III/Euro VI ²	300 Nm at 1200-2200 rpm	1819	1371	5190	13-13.4 12.2-12.6
214 CDi FWD	3.0	Diesel ¹	143 hp (100 kW) at 3800 rpm 4 cylinders 2143 cc	Euro 6b Gr. III/Euro VI ²	330 Nm at 1200-2400 rpm	1819	1371	5190	
311 CDi FWD	3.5	Diesel ¹	114 hp (84 kW) at 3800 rpm 4 cylinders 2143 cc	Euro 6b Gr. III/Euro VI ²	300 Nm at 1200-2200 rpm	1819	1681	5500	
314 CDi FWD	3.5	Diesel ¹	143 hp (100 kW) at 3800 rpm 4 cylinders 2143 cc	Euro 6b Gr. III/Euro VI ²	330 Nm at 1200-2400 rpm	1819	1681	5500	
411 CDi FWD	4.1	Diesel ¹	114 hp (84 kW) at 3800 rpm 4 cylinders 2143 cc	Euro 6b Gr. III/Euro VI ²	300 Nm at 1200-2200 rpm	1858	2242	6100	
414 CDi FWD	4.1	Diesel ¹	143 hp (100 kW) at 3800 rpm 4 cylinders 2143 cc	Euro 6b Gr. III/Euro VI ²	330 Nm at 1200-2400 rpm	1858	2242	6100	
L2									
211 CDi FWD	3.0	Diesel ¹	114 hp (84 kW) at 3800 rpm 4 cylinders 2143 cc	Euro 6b Gr. III/Euro VI ²	300 Nm at 1400-2400 rpm	1834	1356	5190	13.2-15.7 12.3-14.9
214 CDi FWD	3.0	Diesel ¹	143 hp (100 kW) at 3800 rpm 4 cylinders 2143 cc	Euro 6b Gr. III/Euro VI ²	330 Nm at 1200-2400 rpm	1834	1356	5190	
311 CDi FWD	3.5	Diesel ¹	114 hp (84 kW) at 3800 rpm 4 cylinders 2143 cc	Euro 6b Gr. III/Euro VI ²	300 Nm at 1400-2400 rpm	1834	1666	5500	
314 CDi FWD	3.5	Diesel ¹	143 hp (100 kW) at 3800 rpm 4 cylinders 2143 cc	Euro 6b Gr. III/Euro VI ²	330 Nm at 1200-2400 rpm	1834	1666	5500	
311 CDi RWD	3.5	Diesel ¹	114 hp (84 kW) at 3800 rpm 4 cylinders 2143 cc	Euro 6b Gr. III/Euro VI ²	300 Nm at 1400-2400 rpm	1884-1946	1554-1616	5500	
314 CDi RWD	3.5	Diesel ¹	143 hp (100 kW) at 3800 rpm 4 cylinders 2143 cc	Euro 6b Gr. III/Euro VI ²	330 Nm at 1200-2400 rpm	1884-1946	1554-1616	5500	
316 CDi RWD	3.5	Diesel ¹	163 hp (120 kW) at 3800 rpm 4 cylinders 2143 cc	Euro 6b Gr. III/Euro VI ²	360 Nm at 1400-2400 rpm	1884-1946	1554-1616	5500	
319 CDi RWD	3.5	Diesel ¹	190 hp (140 kW) at 3800 rpm 6 cylinders/V 72° 2987 cc	Euro VI	440 Nm at 1400-2400 rpm	1884-1946	1554-1616	5500	
411 CDi FWD	4.1	Diesel ¹	114 hp (84 kW) at 3800 rpm 4 cylinders 2143 cc	Euro 6b Gr. III/Euro VI ²	300 Nm at 1400-2400 rpm	1874	2226	6100	
414 CDi FWD	4.1	Diesel ¹	143 hp (100 kW) at 3800 rpm 4 cylinders 2143 cc	Euro 6b Gr. III/Euro VI ²	330 Nm at 1200-2400 rpm	1874	2226	6100	
514 CDi RWD	5.0	Diesel ¹	143 hp (100 kW) at 3800 rpm 4 cylinders 2143 cc	Euro 6b Gr. III/Euro VI ²	330 Nm at 1200-2400 rpm	2116-2156	2842-2884	7000	
516 CDi RWD	5.0	Diesel ¹	163 hp (120 kW) at 3800 rpm 4 cylinders 2143 cc	Euro 6b Gr. III/Euro VI ²	360 Nm at 1400-2400 rpm	2116-2156	2842-2884	7000	
519 CDi RWD	5.0	Diesel ¹	190 hp (140 kW) at 3800 rpm 6 cylinders/V 72° 2987 cc	Euro VI	440 Nm at 1400-2400 rpm	2116-2156	2842-2884	7000	
L3									
311 CDi RWD	3.5	Diesel ¹	114 hp (84 kW) at 3800 rpm 4 cylinders 2143 cc	Euro 6b Gr. III/Euro VI ²	300 Nm at 1400-2400 rpm	1916-1980	1520-1584	5500	15.2-16.1 14.3-15.3
314 CDi RWD	3.5	Diesel ¹	143 hp (100 kW) at 3800 rpm 4 cylinders 2143 cc	Euro 6b Gr. III/Euro VI ²	330 Nm at 1200-2400 rpm	1916-1980	1520-1584	5500	
316 CDi RWD	3.5	Diesel ¹	163 hp (120 kW) at 3800 rpm 4 cylinders 2143 cc	Euro 6b Gr. III/Euro VI ²	360 Nm at 1400-2400 rpm	1916-1980	1520-1584	5500	
319 CDi RWD	3.5	Diesel ¹	190 hp (140 kW) at 3800 rpm 6 cylinders/V 72° 2987 cc	Euro VI	440 Nm at 1400-2400 rpm	1916-1980	1520-1584	5500	
514 CDi RWD	5.0	Diesel ¹	143 hp (100 kW) at 3800 rpm 4 cylinders 2143 cc	Euro 6b Gr. III/Euro VI ²	330 Nm at 1200-2400 rpm	2154-2196	2804-2846	7000	
516 CDi RWD	5.0	Diesel ¹	163 hp (120 kW) at 3800 rpm 4 cylinders 2143 cc	Euro 6b Gr. III/Euro VI ²	360 Nm at 1400-2400 rpm	2154-2196	2804-2846	7000	
519 CDi RWD	5.0	Diesel ¹	190 hp (140 kW) at 3800 rpm 6 cylinders/V 72° 2987 cc	Euro VI	440 Nm at 1400-2400 rpm	2154-2196	2804-2846	7000	

¹Diesel particulate filter is standard equipment for all diesel engines. ²Euro VI is possible for a reference mass of 2380 kg or higher. Euro VI is added automatically for a reference mass of 2840 kg or higher and added with certain options. ³Figures according to Directive 97/27/EC, version applicable at the time of going to press: Mass of the vehicle in running order means the mass of the unladen vehicle with bodywork, and with coupling device in the case of a towing vehicle, in running order, or the mass of the chassis with cab if the manufacturer does not fit the bodywork and/or coupling device. (including coolant, oils, 90% fuel, 100% other liquids except used waters, tools, spare wheel and driver (75 kg), and, for buses and coaches, the mass of the crew member (75 kg) if there is a crew seat in the vehicle). ⁴For vehicles with all-wheel drive, kerb weight is increased by approx. 130-165 kg. ⁵For vehicles with all-wheel drive, payload decreases by approx. 130-165 kg. ⁶Increased permissible GCW in conjunction with reinforced trailer coupling as optional equipment.

Information in accordance with Regulation (EU) 1230/2012 in the version valid at the time of printing. (With driver 75 kg, all operating fluids and 90% tank filling.) For further information please contact your Mercedes-Benz sales representative. Original accessories can have relevant vehicle characteristics such as weight, rolling and air resistance, and have an influence on the values of consumption and driving performance in addition to traffic and weather conditions.

Fuel consumption and CO₂ emissions - Chassis cab

Please speak to your local Dealer for further information. These figures are for the Chassis cab base vehicle only. The figures will change once the body work is fitted.

FWD Engine	Transmission	CO ₂ emissions combined [g/km]	Fuel economy, urban, mpg	Fuel economy, extra-urban, mpg	Fuel economy, combined, mpg
211CDI L1	6-speed manual	211	31	40.4	36.7
	9-speed automatic	210	33.2	36.2	35.3
211CDI L2	6-speed manual	201	31	40.4	36.7
	9-speed automatic	210	33.2	36.2	35.3
214CDI L1	6-speed manual	201	31	40.4	36.7
	9-speed automatic	210	33.2	36.2	35.3
214CDI L2	6-speed manual	201	31	40.4	36.7
	9-speed automatic	210	33.2	36.2	35.3
311CDI L1	6-speed manual	201	31	40.4	36.7
	9-speed automatic	210	33.2	36.2	35.3
311CDI L2	6-speed manual	201	31	40.4	36.7
	9-speed automatic	210	33.2	36.2	35.3
314CDI L1	6-speed manual	201	31	40.4	36.7
	9-speed automatic	210	33.2	36.2	35.3
314CDI L2	6-speed manual	201	31	40.4	36.7
	9-speed automatic	210	33.2	36.2	35.3
411CDI L1	6-speed manual	211	31	40.4	36.7
	9-speed automatic	210	33.2	36.2	35.3
411CDI L2	6-speed manual	201	31	40.4	36.7
	9-speed automatic	210	33.2	36.2	35.3
414CDI L1	6-speed manual	201	31	40.4	36.7
	9-speed automatic	210	33.2	36.2	35.3
414CDI L2	6-speed manual	201	31	40.4	36.7
	9-speed automatic	210	33.2	36.2	35.3

RWD Engine	Transmission	Rear axle ratio	CO ₂ emissions [g/km]	Fuel economy, urban, mpg	Fuel economy, extra-urban, mpg	Fuel economy, combined, mpg
311CDI L2	6-speed manual	4,182	208	30.1	39.8	35.8
	7-speed automatic	4,182	206	35.3	36.7	35.8
311CDI L3	6-speed manual	4,182	208	30.1	39.8	35.8
	7-speed automatic	4,182	209	34.9	36.2	35.3
314CDI L2	6-speed manual	3,923	198	31.7	40.9	37.2
	7-speed automatic	3,923	202	34.9	37.7	36.7
314CDI L3	6-speed manual	3,923	198	32.1	40.9	37.2
	7-speed automatic	3,923	202	34.9	37.7	36.7
316CDI L2	6-speed manual	3,923	198	31.7	40.9	37.2
	7-speed automatic	3,692	194	36.2	39.2	38.2
316CDI L3	6-speed manual	3,923	198	32.1	40.9	37.2
	7-speed automatic	3,692	194	36.2	39.2	38.2
319CDI L2	7-speed automatic	3,692	249	26.9	31.7	29.7
319CDI L3	7-speed automatic	3,692	249	26.9	31.7	29.7
514CDI L2	6-speed manual	4,727	185	36.2	43.5	40.4
	7-speed automatic	4,182	205	29.7	41.5	36.2
514CDI L3	6-speed manual	4,727	185	36.2	43.5	40.4
	7-speed automatic	4,182	208	29.4	40.9	35.8
516CDI L2	6-speed manual	4,182	199	30.7	42.8	37.2
	7-speed automatic	4,182	205	29.7	41.5	36.2
516CDI L3	6-speed manual	4,182	199	30.7	42.8	37.2
	7-speed automatic	4,182	208	29.4	40.9	35.8
519CDI L2	7-speed automatic	3,692	249	26.9	31.7	29.7
519CDI L3	7-speed automatic	3,692	249	26.9	31.7	29.7

CDI engines certified in accordance with Euro 6c Gr. III as standard. The figures indicated have been calculated in accordance with the prescribed measuring process (Directive [EC] 715/2007 in the currently applicable version). The figures are not based on an individual vehicle model and do not constitute part of the product offer; they are provided solely for purposes of comparison between vehicle models. Table shows values for vehicles with manual transmission.

The stated values have been determined according to the respective measuring method (according to Regulation (EC) No 715/2007, as amended). Note: The information does not refer to a single vehicle and is not part of the offer, but serves solely for purposes of comparison between the different vehicle types. CO₂ emissions resulting from the production and supply of fuel or other energy sources are not taken into account when CO₂ emissions are determined in accordance with Directive 1999/94 / EC.

Fuel consumption and CO₂ emissions - Chassis cab

Please speak to your local Dealer for further information. These figures are for the Chassis cab base vehicle only. The figures will change once the body work is fitted.

AWD Engine	Transmission	Rear axle ratio	CO ₂ emissions [g/km]	Fuel economy, urban, mpg	Fuel economy, extra-urban, mpg	Fuel economy, combined, mpg
316CDI L2	6-speed manual	TBC	TBC	TBC	TBC	TBC
	7-speed automatic	TBC	TBC	TBC	TBC	TBC
316CDI L3	6-speed manual	TBC	TBC	TBC	TBC	TBC
	7-speed automatic	TBC	TBC	TBC	TBC	TBC
319CDI L2	7-speed automatic	TBC	TBC	TBC	TBC	TBC
319CDI L3	7-speed automatic	TBC	TBC	TBC	TBC	TBC
516CDI L2	6-speed manual	TBC	TBC	TBC	TBC	TBC
	7-speed automatic	TBC	TBC	TBC	TBC	TBC
516CDI L3	6-speed manual	TBC	TBC	TBC	TBC	TBC
	7-speed automatic	TBC	TBC	TBC	TBC	TBC
519CDI L2	7-speed automatic	TBC	TBC	TBC	TBC	TBC
519CDI L3	7-speed automatic	TBC	TBC	TBC	TBC	TBC

CDI engines certified in accordance with Euro 6c Gr. III as standard. The figures indicated have been calculated in accordance with the prescribed measuring process (Directive [EC] 715/2007 in the currently applicable version). The figures are not based on an individual vehicle model and do not constitute part of the product offer; they are provided solely for purposes of comparison between vehicle models.

Table shows values for vehicles with manual transmission.

The stated values have been determined according to the respective measuring method (according to Regulation (EC) No 715/2007, as amended). Note: The information does not refer to a single vehicle and is not part of the offer, but serves solely for purposes of comparison between the different vehicle types. CO₂ emissions resulting from the production and supply of fuel or other energy sources are not taken into account when CO₂ emissions are determined in accordance with Directive 1999/94 / EC.

Dimensions - Chassis crewcab (RWD)

Chassis crewcab L2 RWD



Chassis crewcab L3 RWD



Technical data - Chassis crewcab

These figures are for the Chassis crewcab base vehicle only. The figures will change once the body work is fitted.

	Perm GVW (t)	Fuel	Engine output	Emission standard	Torque	Kerb weight ^{3,4} , kg	Payload ⁵ , kg	Perm Gross Combination Weight, kg	Turning circle Ø, m Track circle Ø, m
L2									
311 CDi RWD	3.5	Diesel ¹	114 hp (84 kW) at 3800 rpm 4 cylinders 2143 cc	Euro 6b Gr. III/Euro VI ²	300 Nm at 1400-2400 rpm	2074-2136	1364-1426	5500	13.2-15.7 12.3-14.9
314 CDi RWD	3.5	Diesel ¹	143 hp (100 kW) at 3800 rpm 4 cylinders 2143 cc	Euro 6b Gr. III/Euro VI ²	330 Nm at 1200-2400 rpm	2074-2136	1364-1426	5500	
316 CDi RWD	3.5	Diesel ¹	163 hp (120 kW) at 3800 rpm 4 cylinders 2143 cc	Euro 6b Gr. III/Euro VI ²	360 Nm at 1400-2400 rpm	2074-2136	1364-1426	5500	
319 CDi RWD	3.5	Diesel ¹	190 hp (140 kW) at 3800 rpm 6 cylinders/V 72° 2987 cc	Euro VI	440 Nm at 1400-2400 rpm	2074-2136	1364-1426	5500	
514 CDi RWD	5.0	Diesel ¹	143 hp (100 kW) at 3800 rpm 4 cylinders 2143 cc	Euro 6b Gr. III/Euro VI ²	330 Nm at 1200-2400 rpm	2302-2344	2656-2698	7000	
516 CDi RWD	5.0	Diesel ¹	163 hp (120 kW) at 3800 rpm 4 cylinders 2143 cc	Euro 6b Gr. III/Euro VI ²	360 Nm at 1400-2400 rpm	2302-2344	2656-2698	7000	
519 CDi RWD	5.0	Diesel ¹	190 hp (140 kW) at 3800 rpm 6 cylinders/V 72° 2987 cc	Euro VI	440 Nm at 1400-2400 rpm	2302-2344	2656-2698	7000	
L3									
311 CDi RWD	3.5	Diesel ¹	114 hp (84 kW) at 3800 rpm 4 cylinders 2143 cc	Euro 6b Gr. III/Euro VI ²	300 Nm at 1400-2400 rpm	2096-2158	1342-1404	5500	13.2-15.7 12.3-14.9
316 CDi RWD	3.5	Diesel ¹	163 hp (120 kW) at 3800 rpm 4 cylinders 2143 cc	Euro 6b Gr. III/Euro VI ²	360 Nm at 1400-2400 rpm	2096-2158	1342-1404	5500	
319 CDi RWD	3.5	Diesel ¹	190 hp (140 kW) at 3800 rpm 6 cylinders/V 72° 2987 cc	Euro VI	440 Nm at 1400-2400 rpm	2096-2158	1342-1404	5500	
514 CDi RWD	5.0	Diesel ¹	143 hp (100 kW) at 3800 rpm 4 cylinders 2143 cc	Euro 6b Gr. III/Euro VI ²	330 Nm at 1200-2400 rpm	2340-2382	2618-2660	7000	
516 CDi RWD	5.0	Diesel ¹	163 hp (120 kW) at 3800 rpm 4 cylinders 2143 cc	Euro 6b Gr. III/Euro VI ²	360 Nm at 1400-2400 rpm	2340-2382	2618-2660	7000	
519 CDi RWD	5.0	Diesel ¹	190 hp (140 kW) at 3800 rpm 6 cylinders/V 72° 2987 cc	Euro VI	440 Nm at 1400-2400 rpm	2340-2382	2618-2660	7000	

¹Diesel particulate filter is standard equipment for all diesel engines. ²Euro VI is possible for a reference mass of 2380 kg or higher. Euro VI is added automatically for a reference mass of 2840 kg or higher and added with certain options. ³ Figures according to Directive 97/27/EC, version applicable at the time of going to press: Mass of the vehicle in running order means the mass of the unladen vehicle with bodywork, and with coupling device in the case of a towing vehicle, in running order, or the mass of the chassis with cab if the manufacturer does not fit the bodywork and/or coupling device. (Including coolant, oils, 90% fuel, 100% other liquids except used waters, tools, spare wheel and driver (75 kg), and, for buses and coaches, the mass of the crew member (75 kg) if there is a crew seat in the vehicle). ⁴For vehicles with all-wheel drive, kerb weight is increased by approx. 130-165 kg. ⁵For vehicles with all-wheel drive, payload decreases by approx. 130-165 kg. ⁶Increased permissible GCW in conjunction with reinforced trailer coupling as optional equipment.

Information in accordance with Regulation (EU) 1230/2012 in the version valid at the time of printing. (With driver 75 kg, all operating fluids and 90% tank filling.) For further information please contact your Mercedes-Benz sales representative. Original accessories can have relevant vehicle characteristics such as weight, rolling and air resistance, and have an influence on the values of consumption and driving performance in addition to traffic and weather conditions.

Fuel consumption and CO₂ emissions - Chassis crewcab

Please speak to your local Dealer for further information. These figures are for the Chassis crewcab base vehicle only. The figures will change once the bodywork is fitted.

RWD Engine	Transmission	Rear axle ratio	CO ₂ emissions [g/km]	Fuel economy, urban, mpg	Fuel economy, extra-urban, mpg	Fuel economy, combined, mpg
311CDI L2	6-speed manual	4,182	211	29.7	39.2	35.3
	7-speed automatic	4,182	212	34.4	35.8	34.9
311CDI L3	6-speed manual	4,182	214	29.4	38.7	34.4
	7-speed automatic	4,182	212	34.4	35.8	34.9
314CDI L2	6-speed manual	3,923	201	32.1	39.8	36.7
	7-speed automatic	3,923	208	33.6	36.7	35.8
314CDI L3	6-speed manual	TBD	TBD	TBD	TBD	TBD
	7-speed automatic	TBD	TBD	TBD	TBD	TBD
316CDI L2	6-speed manual	3,923	201	32.1	39.8	36.7
	7-speed automatic	3,692	200	35.3	37.7	37.2
316CDI L3	6-speed manual	3,923	204	31.7	39.2	36.2
	7-speed automatic	3,692	200	35.3	37.7	37.2
319CDI L2	7-speed automatic	3,692	TBD	TBD	TBD	TBD
319CDI L3	7-speed automatic	3,692	TBD	TBD	TBD	TBD
514CDI L2	6-speed manual	4,727	185	36.2	43.5	40.4
	7-speed automatic	4,182	205	29.7	41.5	36.2
514CDI L3	6-speed manual	4,727	185	36.2	43.5	40.4
	7-speed automatic	4,182	205	29.7	41.5	36.2
516CDI L2	6-speed manual	4,182	199	30.7	42.8	37.2
	7-speed automatic	4,182	205	29.7	41.5	36.2
516CDI L3	6-speed manual	4,182	199	30.7	42.8	37.2
	7-speed automatic	4,182	205	29.7	41.5	36.2
519CDI L2	7-speed automatic	3,692	TBD	TBD	TBD	TBD
519CDI L3	7-speed automatic	3,692	TBD	TBD	TBD	TBD

The stated values have been determined according to the respective measuring method (according to Regulation (EC) No 715/2007, as amended). Note: The information does not refer to a single vehicle and is not part of the offer, but serves solely for purposes of comparison between the different vehicle types. CO₂ emissions resulting from the production and supply of fuel or other energy sources are not taken into account when CO₂ emissions are determined in accordance with Directive 1999/94 / EC.

Fuel consumption and CO₂ emissions - Chassis crewcab

Please speak to your local Dealer for further information. These figures are for the Chassis crewcab base vehicle only. The figures will change once the bodywork is fitted.

AWD Engine	Transmission	Rear axle ratio	CO ₂ emissions [g/km]	Fuel economy, urban, mpg	Fuel economy, extra-urban, mpg	Fuel economy, combined, mpg
516CDI L2	6-speed manual	TBC	TBC	TBC	TBC	TBC
	7-speed automatic	TBC	TBC	TBC	TBC	TBC
516CDI L3	6-speed manual	TBC	TBC	TBC	TBC	TBC
	7-speed automatic	TBC	TBC	TBC	TBC	TBC
519CDI L2	7-speed automatic	TBC	TBC	TBC	TBC	TBC
519CDI L3	7-speed automatic	TBC	TBC	TBC	TBC	TBC

The stated values have been determined according to the respective measuring method (according to Regulation (EC) No 715/2007, as amended). Note: The information does not refer to a single vehicle and is not part of the offer, but serves solely for purposes of comparison between the different vehicle types. CO₂ emissions resulting from the production and supply of fuel or other energy sources are not taken into account when CO₂ emissions are determined in accordance with Directive 1999/94 / EC.

Dimensions - Dropside

Dropside L2 FWD

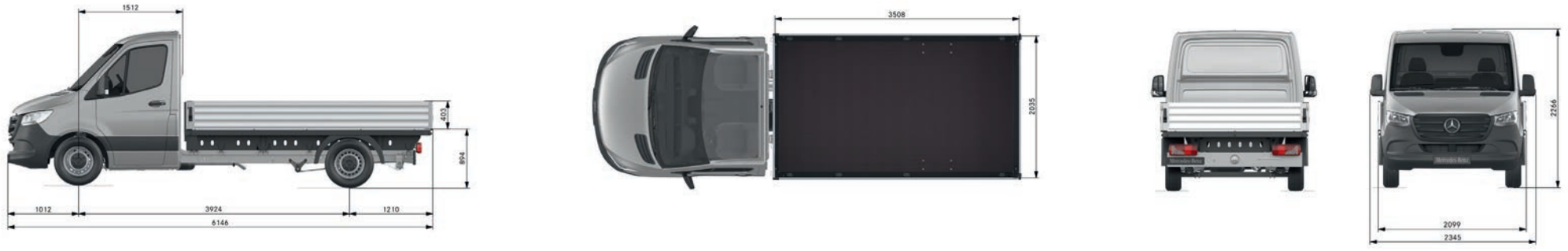

Dropside L2 (RWD)



Dropside L3 (RWD)



Please note: The stated vehicle dimensions and payload weights are correct according to type approval data. The specific payload values for UK supplied vehicles may differ. The figure quoted does not account for equipment which is included in the UK product offer as standard.

Technical data - Dropside

	Perm GVW (t)	Fuel	Engine output	Emission standard	Torque	Kerb weight ^{3,4} , kg	Payload ⁵ , kg	Perm Gross Combination Weight, kg	Cargo area, m ² Max. loading length, mm	Turning circle Ø, m Track circle Ø, m
L2										
311 CDi FWD	3.5	Diesel ¹	114 hp (84 kW) at 3800 rpm 4 cylinders 2143 cc	Euro 6b Gr. III/Euro VI ²	300 Nm at 1400-2400 rpm	2140	1360	5500	6.935-7.139-7.703m ² 3408-3508-3608mm	13.3-15.2 12.4-14.4
314 CDi FWD	3.5	Diesel ¹	143 hp (100 kW) at 3800 rpm 4 cylinders 2143 cc	Euro 6b Gr. III/Euro VI ²	330 Nm at 1200-2400 rpm	2140	1360	5500		
311 CDi RWD	3.5	Diesel ¹	114 hp (84 kW) at 3800 rpm 4 cylinders 2143 cc	Euro 6b Gr. III/Euro VI ²	300 Nm at 1400-2400 rpm	2174-2236	1264-1326	5500		
314 CDi RWD	3.5	Diesel ¹	143 hp (100 kW) at 3800 rpm 4 cylinders 2143 cc	Euro 6b Gr. III/Euro VI ²	330 Nm at 1200-2400 rpm	2174-2236	1264-1326	5500		
316 CDi RWD	3.5	Diesel ¹	163 hp (120 kW) at 3800 rpm 4 cylinders 2143 cc	Euro 6b Gr. III/Euro VI ²	360 Nm at 1400-2400 rpm	2174-2236	1264-1326	5500		
319 CDi RWD	3.5	Diesel ¹	190 hp (140 kW) at 3800 rpm 6 cylinders/V 72° 2987 cc	Euro VI	440 Nm at 1400-2400 rpm	2174-2236	1264-1326	5500		
514 CDi RWD	5.0	Diesel ¹	143 hp (100 kW) at 3800 rpm 4 cylinders 2143 cc	Euro 6b Gr. III/Euro VI ²	330 Nm at 1200-2400 rpm	2470-2512	2488-2530	7000		
516 CDi RWD	5.0	Diesel ¹	163 hp (120 kW) at 3800 rpm 4 cylinders 2143 cc	Euro 6b Gr. III/Euro VI ²	360 Nm at 1400-2400 rpm	2470-2512	2488-2530	7000		
519 CDi RWD	5.0	Diesel ¹	190 hp (140 kW) at 3800 rpm 6 cylinders/V 72° 2987 cc	Euro VI	440 Nm at 1400-2400 rpm	2470-2512	2488-2530	7000		
L3										
311 CDi RWD	3.5	Diesel ¹	114 hp (84 kW) at 3800 rpm 4 cylinders 2143 cc	Euro 6b Gr. III/Euro VI ²	300 Nm at 1400-2400 rpm	2266-2330	1170-1234	5500	8.766m ² 4308mm	13.3-15.2 12.4-14.4
314 CDi RWD	3.5	Diesel ¹	143 hp (100 kW) at 3800 rpm 4 cylinders 2143 cc	Euro 6b Gr. III/Euro VI ²	330 Nm at 1200-2400 rpm	2266-2330	1170-1234	5500		
316 CDi RWD	3.5	Diesel ¹	163 hp (120 kW) at 3800 rpm 4 cylinders 2143 cc	Euro 6b Gr. III/Euro VI ²	360 Nm at 1400-2400 rpm	2266-2330	1170-1234	5500		
319 CDi RWD	3.5	Diesel ¹	190 hp (140 kW) at 3800 rpm 6 cylinders/V 72° 2987 cc	Euro VI	440 Nm at 1400-2400 rpm	2266-2330	1170-1234	5500		
514 CDi RWD	5.0	Diesel ¹	143 hp (100 kW) at 3800 rpm 4 cylinders 2143 cc	Euro 6b Gr. III/Euro VI ²	330 Nm at 1200-2400 rpm	2471-2613	2387-2429	7000		
516 CDi RWD	5.0	Diesel ¹	163 hp (120 kW) at 3800 rpm 4 cylinders 2143 cc	Euro 6b Gr. III/Euro VI ²	360 Nm at 1400-2400 rpm	2471-2613	2387-2429	7000		
519 CDi RWD	5.0	Diesel ¹	190 hp (140 kW) at 3800 rpm 6 cylinders/V 72° 2987 cc	Euro VI	440 Nm at 1400-2400 rpm	2471-2613	2387-2429	7000		

¹Diesel particulate filter is standard equipment for all diesel engines. ²Euro VI is possible for a reference mass of 2380 kg or higher. Euro VI is added automatically for a reference mass of 2840 kg or higher and added with certain options. ³ Figures according to Directive 97/27/EC, version applicable at the time of going to press: Mass of the vehicle in running order means the mass of the unladen vehicle with bodywork, and with coupling device in the case of a towing vehicle, in running order, or the mass of the chassis with cab if the manufacturer does not fit the bodywork and/or coupling device. (including coolant, oils, 90% fuel, 100% other liquids except used waters, tools, spare wheel and driver (75 kg), and, for buses and coaches, the mass of the crew member (75 kg) if there is a crew seat in the vehicle). ⁴For vehicles with all-wheel drive, kerb weight is increased by approx. 130-165 kg. ⁵For vehicles with all-wheel drive, payload decreases by approx. 130-165 kg. ⁶Increased permissible GCW in conjunction with reinforced trailer coupling as optional equipment.

Information in accordance with Regulation (EU) 1230/2012 in the version valid at the time of printing. (With driver 75 kg, all operating fluids and 90% tank filling.) ⁵ The real consumption values are, a. depending on the vehicle weight and the selected equipment. For further information please contact your Mercedes-Benz sales representative. Original accessories can have relevant vehicle characteristics such as weight, rolling and air resistance, and have an influence on the values of consumption and driving performance in addition to traffic and weather conditions.

Fuel consumption and CO₂ emissions - Dropside

Please speak to your local Dealer for further information.

FWD Engine	Transmission	CO ₂ emissions combined [g/km]	Fuel economy, urban, mpg	Fuel economy, extra-urban, mpg	Fuel economy, combined, mpg
311 CDI L2	6-speed manual	208	30.1	38.7	35.8
	9-speed automatic	216	32.8	34.9	34.4
314 CDI L2	6-speed manual	208	30.1	38.7	35.8
	9-speed automatic	216	32.8	34.9	34.4

RWD Engine	Transmission	Rear axle ratio	CO ₂ emissions [g/km]	Fuel economy, urban, mpg	Fuel economy, extra-urban, mpg	Fuel economy, combined, mpg
311 CDI L2	6-speed manual	4,182	214	29.4	38.7	34.9
	7-speed automatic	4,182	215	34	35.8	34.4
311 CDI L3	6-speed manual	4,182	217	29.4	38.2	34
	7-speed automatic	4,182	214	34	35.8	34.4
314 CDI L2	6-speed manual	3,923	204	31.7	39.2	36.2
	7-speed automatic	3,923	211	32.8	36.7	35.3
314 CDI L3	6-speed manual	3,923	207	31.7	38.7	35.8
	7-speed automatic	3,923	211	32.8	36.7	35.3
316 CDI L2	6-speed manual	3,923	198	31.7	39.2	36.2
	7-speed automatic	3,692	194	36.2	39.2	38.2
316 CDI L3	6-speed manual	3,923	198	32.8	40.9	37.2
	7-speed automatic	3,692	203	34.9	37.2	36.2
319 CDI L2	7-speed automatic	3,692	249	26.9	31.7	29.7
319 CDI L3	7-speed automatic	3,692	249	26.9	31.7	29.7
514 CDI L2	6-speed manual	4,727	185	36.2	43.5	40.4
	7-speed automatic	4,182	205	29.7	41.5	36.2
514 CDI L3	6-speed manual	4,727	185	36.2	43.5	40.4
	7-speed automatic	4,182	208	29.4	40.9	35.8
516 CDI L2	6-speed manual	4,182	199	30.7	42.8	37.2
	7-speed automatic	4,182	205	29.7	41.5	36.2
516 CDI L3	6-speed manual	4,182	199	30.7	42.8	37.2
	7-speed automatic	4,182	208	29.4	40.9	35.8
519 CDI L2	7-speed automatic	3,692	249	26.9	31.7	29.7
519 CDI L3	7-speed automatic	3,692	249	26.9	31.7	29.7

The stated values have been determined according to the respective measuring method (according to Regulation (EC) No 715/2007, as amended). Note: The information does not refer to a single vehicle and is not part of the offer, but serves solely for purposes of comparison between the different vehicle types. CO₂ emissions resulting from the production and supply of fuel or other energy sources are not taken into account when CO₂ emissions are determined in accordance with Directive 1999/94 / EC.

Fuel consumption and CO₂ emissions - Dropside

Please speak to your local Dealer for further information.

AWD Engine	Transmission	Rear axle ratio	CO ₂ emissions [g/km]	Fuel economy, urban, mpg	Fuel economy, extra-urban, mpg	Fuel economy, combined, mpg
316CDI L2	6-speed manual	TBC	TBC	TBC	TBC	TBC
	7-speed automatic	TBC	TBC	TBC	TBC	TBC
316CDI L3	6-speed manual	TBC	TBC	TBC	TBC	TBC
	7-speed automatic	TBC	TBC	TBC	TBC	TBC
319CDI L2	7-speed automatic	TBC	TBC	TBC	TBC	TBC
319CDI L3	7-speed automatic	TBC	TBC	TBC	TBC	TBC
516CDI L2	6-speed manual	TBC	TBC	TBC	TBC	TBC
	7-speed automatic	TBC	TBC	TBC	TBC	TBC
516CDI L3	6-speed manual	TBC	TBC	TBC	TBC	TBC
	7-speed automatic	TBC	TBC	TBC	TBC	TBC
519CDI L2	7-speed automatic	TBC	TBC	TBC	TBC	TBC
519CDI L3	7-speed automatic	TBC	TBC	TBC	TBC	TBC

The stated values have been determined according to the respective measuring method (according to Regulation (EC) No 715/2007, as amended). Note: The information does not refer to a single vehicle and is not part of the offer, but serves solely for purposes of comparison between the different vehicle types. CO₂ emissions resulting from the production and supply of fuel or other energy sources are not taken into account when CO₂ emissions are determined in accordance with Directive 1999/94 / EC.

Equipment

A list of both standard and optional features available.

Category	Description	Option code	Front-wheel drive		Rear-wheel drive		All-wheel drive		List price, ex. VAT
			Van	Chassis cab / crewcab	Van	Chassis cab / crewcab	Van	Chassis cab / crewcab	
Airbags	Airbag driver's seat	SA5	●	●	●	●	●	●	£0.00
	Airbag co-driver's seat. Includes: seat belt reminder for co-driver's seat	SA6	○	○	○	○	○	○	£415.00
	Thorax/pelvis/side airbag for driver. Includes: front airbag co-driver (SA6) and seat belt reminder (J55)	SH1	○	○	○	○	○	○	£755.00
	Thorax/pelvis/side airbag for co-driver. Includes: thorax/pelvis/side airbag for driver (SH1), front airbag co-driver (SA6) and seat belt reminder (J55)	SH2	○	○	○	○	○	○	£990.00
	Window airbags for driver and co-driver	SH9	○	○	○	○	○	○	£575.00
Alternators	Alternator 14 V / 220 A	M46	-	-	○	○	○	○	£460.00
	Alternator 14 V / 230 A	M48	○	○	-	-	-	-	£460.00
	Alternator 14 V / 250 A	M60	-	-	○	○	○	○	£460.00
	Alternator 14 V / 280 A	M61	-	-	○	○	○	○	£750.00
	Alternator 14 V/200 A	M40	-	-	○	○	○	○	£0.00
	Alternator 14 V / 180 A	M49	-	-	●	●	●	●	£0.00
Audio	Digital radio (DAB)	E1D	●	●	●	●	●	●	£0.00
	MBUX multimedia system with 7-inch touch screen	E3M	●	●	●	●	●	●	£0.00
	MBUX multimedia system with 10.25-inch touch screen	E4M	○	○	○	○	○	○	£1,810.00
	2-way loudspeakers, front and rear	EL9	-	-	○	-	○	-	£750.00
Axle	Rear axle springs made of glass-fibre-reinforced plastic	C83	○	○	○	○	-	-	£240.00
	Front axle with increased load capacity	A50	●	●	○	○	-	-	£260.00

Category	Description	Option code	Front-wheel drive		Rear-wheel drive		All-wheel drive		List price, ex. VAT
			Van	Chassis cab / crewcab	Van	Chassis cab / crewcab	Van	Chassis cab / crewcab	
Battery	Auxiliary battery for retrofit consumer's vehicle interior. Includes: cut-off relay for auxiliary battery (E36)	E2I	○	○	○	○	○	○	£325.00
	Auxiliary battery for retrofit consumer's engine compartment	E2M	-	-	○	○	○	○	£235.00
	Battery master switch, single-pin	E30	○	○	○	○	○	○	£105.00
	Cut-off relay for auxiliary battery	E36	○	○	○	○	○	○	£95.00
	AGM battery, 12 V 70 Ah	ED1	○	○	○	○	○	○	£0.00
	Heavy-duty battery (12v 92 aH)	ED4	●	●	●	●	●	●	£0.00
	Jump start contact	ES0	●	●	●	●	●	●	£0.00
	Engine run-on system (Note exemption may be required)	MW1	○	○	○	○	○	○	£810.00
Brake	Active Brake Assist	BA3	●	●	●	●	●	●	£0.00
	Adaptive brake light	LE1	●	●	●	●	●	●	£0.00
	Hill-Start Assist	E07	●	●	●	●	●	●	£0.00
	HOLD function (Braking assistance on downhill stretches and at a traffic light stop)	BH1	○	○	○	○	○	○	£0.00
	Folding handbrake lever	BE2	○	○	○	○	○	○	£55.00
	Electrical parking brake	B25	○	○	○	○	○	○	£270.00
	Chock	Y26	○	○	○	○	○	○	£45.00

Category	Description	Option code	Front-wheel drive		Rear-wheel drive		All-wheel drive		List price, ex. VAT
			Van	Chassis cab / crewcab	Van	Chassis cab / crewcab	Van	Chassis cab / crewcab	
Bodywork	Stowage boxes left and right under platform	PZ7	-	○	-	○	-	○	£150.00
	Dropside pickup body with full height headboard and ladder rack Note: Only applies to chassis' 3.5 t and over. Also included in this package:	N32Z	-	○	-	○	-	○	£2,670.00
	Ladder carrier behind cab	PZ9	-	○	-	○	-	○	
	Platform with aluminium side boards	P02	-	○	-	○	-	○	
	Suspension for comfort and load protraction	CB1	-	○	-	○	-	○	
	Dropside pickup body with full height headboard and ladder rack Note: Only applies to chassis' under 3.5 t. Also included in this package:	N32Z	-	○	-	○	-	○	£2,175.00
	Ladder carrier behind cab	PZ9	-	○	-	○	-	○	
	Platform with aluminium side boards	P02	-	○	-	○	-	○	
	Suspension for comfort and load protraction	CB1	-	○	-	○	-	○	
	Crew Van body pack Includes:	N33Z	○	-	○	-	○	-	£1,715.00
Front axle with upgraded load	A50	○	-	○	-	○	-		
Seats passenger compartment, 3-seater bench 1st row	U60	○	-	○	-	○	-		
Crew cab floor assy	V40	○	-	○	-	○	-		
Half-height load compartment panelling	VA1	○	-	○	-	○	-		
Window front left, fixed in sidewall/sliding door	W16	○	-	○	-	○	-		
Front right window, fixed in sidewall/sliding door	W17	○	-	○	-	○	-		
Longitudinal member reinforcement	Q11	●	●	●	●	●	●	£0.00	
End cross member bolted	Q18	-	○	-	○	-	○	£35.00	
Bulkhead	Full-width partition	D50	●	-	●	-	●	-	£0.00
	Full-width partition wall at C-pillar. Includes: Crew cab floor assy (V40) + Half-height load compartment panelling (VA1) + Front left window, fixed, in sidewall/sliding door (W16) + Front right window fixed in side wall/sliding door (W17) + Panelling under roof (V36) + High roof (D03) + Seats passenger compartment, 2-seater bench 1st row (U60)	D56	○	-	○	-	○	-	£2,840.00
	Partition wall with sliding door Note: Not available in conjunction with Stowage compartment above roof panelling (FF4) or super-high roof (D05) or paint in vehicle colour (D06). Includes: High roof (D03) + Co-driver's seat (S91). Seat base for front passenger's seat not provided (S99)	D64	○	○	○	-	○	-	£2,125.00
	Full-width partition wall with 1 window	D51	○	-	○	-	○	-	£85.00
	Omission of partition	D93	○	-	○	-	○	-	£0.00
	Provision for retro-fitting partition	D62	○	-	○	-	○	-	£0.00

Category	Description	Option code	Front-wheel drive		Rear-wheel drive		All-wheel drive		List price, ex. VAT
			Van	Chassis cab / crewcab	Van	Chassis cab / crewcab	Van	Chassis cab / crewcab	
Doors	Power closing aid, sliding door in left side	T51	○	-	○	-	○	-	£250.00
	Power closing aid, sliding door in right side. Includes: Sliding door right side (T16)	T50	○	-	○	-	○	-	£815.00
	Electrical operation of sliding door in left side. Includes: Multi-button key (FY7)	T56	-	-	○	-	○	-	£685.00
	Electrical operation of sliding door in right side. Note: Only available for vehicles with rear-wheel drive. Includes: Sliding door right (T16) + Multi-button key (FY7)	T55	-	-	○	-	○	-	£1,250.00
	Double-wing rear-end doors, opening to side wall. Note: Not available for L1 vehicles	W54	●	-	●	-	●	-	£0.00
	Sliding door left	T19	●	-	●	-	●	-	£0.00
	Sliding door right	T16	○	-	○	-	○	-	£565.00
	Opening limiter, electrically operated sliding door	T60	-	-	○	-	○	-	£800.00
Electronics	12 V socket in the boot/load compartment	ES2	○	-	○	-	○	-	£50.00
	Plug socket in cab	E46	○	○	○	○	○	○	£45.00
	Tray for smartphones. Includes: Wireless charging	E1B	○	○	○	○	○	○	£1,140.00
	Smartphone cradle	E11	○	○	○	○	○	○	£70.00
	USB-C socket, 5 V	E1U	●	●	●	●	●	●	£0.00
	Prewiring for parameterizable special module (PSM)	ED8	●	●	●	●	-	-	£0.00
	Parameterizable special module	ED5	○	○	○	○	●	●	£285.00
	Electrical components for trailer socket	E57	○	○	○	○	○	○	£105.00
	Extension of Programmable System Module (PSM) standard contact (Additional connection options for body manufacturers)	E5M	○	○	○	○	○	○	£60.00
	Terminal strip for electrical connection	EK1	●	●	●	●	●	●	£0.00
	Charging package, dashboard (Two 5v USB-C sockets and 12v socket)	ES5	○	○	○	○	○	○	£65.00
Pre-installation for 3-way tipper	P57	-	○	-	○	-	○	£950.00	

Category	Description	Option code	Front-wheel drive		Rear-wheel drive		All-wheel drive		List price, ex. VAT
			Van	Chassis cab / crewcab	Van	Chassis cab / crewcab	Van	Chassis cab / crewcab	
Exhaust	Exhaust straight to chassis rear	K60	○	○	○	○	○	○	£115.00
	Exhaust ending laterally behind rear axle	K63	-	-	○	-	○	-	£105.00
	Lateral exhaust pipe in front of rear axle, left	KA3	-	-	○	○	○	○	£45.00
Exterior	Chrome-plated radiator grille. Includes: Radiator grille frame in vehicle colour (CN2)	FK3	○	○	○	○	○	○	£205.00
	Communication module (LTE) for digital services	JH3	●	●	●	●	●	●	£0.00
	Instrument cluster with colour display	JK5	○	○	○	○	○	○	£140.00
Fuel tank	Main tank, 93 litres. Note: RWD only	KB7	-	-	○	○	●	●	£270.00
	AdBlue filler cap, lockable	K53	○	○	○	○	○	○	£20.00
	Tank 65 litres. Note: FWD only	K08	●	●	-	-	-	-	£0.00
	Tank 71 litres. Note: RWD only	K09	-	-	●	●	-	-	£0.00
	Main tank 50 litres. Note: FWD only	K11	○	○	-	-	-	-	£0.00
	Filler cap, diesel, in red	K56	○	○	○	○	○	○	£20.00
	Main tank, 92 litres. Note: FWD only	KB8	○	○	-	-	-	-	£265.00
	Fuel filter with water separator	KL5	●	●	●	●	●	●	£0.00
Gearbox	7G-TRONIC PLUS Note: Available for vehicles with RWD and AWD*. Includes: HOLD function (BH1)	G42	-	-	○	○	○	○	£1,520.00
	9G-TRONIC. Note: FWD only	GK8	○	○	-	-	-	-	£1,930.00
Grab handles	Handle for entrance	T74	○	○	○	○	○	○	£40.00
	Grab handles for driver's and co-driver's doors	T75	○	○	○	○	●	●	£65.00
	Grab handle, load compartment sliding door at partition	T77	●	○	●	○	●	○	£0.00
	Entrance handle on left-hand rear corner pillar	T85	○	-	○	-	○	-	£40.00
	Entrance handle on right-hand rear corner pillar	T86	○	-	○	-	○	-	£0.00
	Grab handle for inner seat, two-seater	S78	○	○	○	○	○	○	£45.00

*Expected to be available from Q2 2019.

● Standard ○ Optional - Not available

Category	Description	Option code	Front-wheel drive		Rear-wheel drive		All-wheel drive		List price, ex. VAT
			Van	Chassis cab / crewcab	Van	Chassis cab / crewcab	Van	Chassis cab / crewcab	
Gross Vehicle Weight (GVW)	Weight variant 3,500 kg. Weight variant X16 is available as a downrated payload variant for vehicles of the weight class 5,000 kg with rear-wheel drive	X16	-	-	○	○	○	○	£0.00
	Weight variant 4,250 kg. Weight variant XG5 is available as a downrated payload variant for vehicles of the weight class 5,000 kg with rear-wheel drive	XG5	-	-	○	○	○	○	£0.00
	Weight variant 3,550 kg. XG4 is available as a uprated payload variant for vehicles of the weight class 3,500 kg with front or rear-wheel drive	XG4	○	○	○	○	○	○	£0.00
	Weight variant 2,800 kg. XG6 is available as a downrated payload variant for vehicles of the weight classes 3,000 kg and 3,500 kg with front-wheel drive	XG6	○	○	-	-	-	-	£0.00
	Weight variant 4,100 kg	XL2	○	○	○	○	○	○	£0.00
	Weight variant 5,030 kg. XL6 is available as a uprated payload variant for vehicles of the weight class 5,000 kg with rear-wheel drive	XL6	-	-	○	○	○	○	£0.00
	Higher weight 3,880 kg. XL8 is available as a downrated payload variant for vehicles of the weight class 4,100 kg with front or rear-wheel drive	XL8	○	○	○	○	○	○	£0.00
	Weight variant 5,500 kg. The speed is limited to 90 km/h, trailer operations are only possible in conjunction with the optional retarder. Option includes: Make of tyres - Continental (RF1) + Tyres 205/75 R16 C (RG3) + Make of tyres as optional extra (RM9) + Front axle with upgraded axle load (A50)	XL4	-	-	○	○	○	○	£1,630.00

Category	Description	Option code	Front-wheel drive		Rear-wheel drive		All-wheel drive		List price, ex. VAT
			Van	Chassis cab / crewcab	Van	Chassis cab / crewcab	Van	Chassis cab / crewcab	
Heating and ventilation	Auxiliary heat exchanger at the rear. Includes: Heater booster system (HZ9). Sliding door not provided (T93)	H13	○	-	○	-	○	-	£1,040.00
	Heating duct to passenger compartment	H00	-	-	○	○	○	○	£55.00
	Roof-mounted air conditioning system, reinforced	H08	○	○	○	○	○	○	£3,620.00
	TEMPMATIC semi-automatic climate control system	HH9	-	-	○	○	○	○	£1,000.00
	TEMPMATIC semi-automatic climate control system. Includes Alternator 14V/230A (M48)	HH9	○	○	-	-	-	-	£1,155.00
	Heater booster system	HZ9	○	○	○	○	○	○	£485.00
	Hot-water auxiliary heater	H12	○	○	○	○	○	○	£625.00
	Electric hot-air auxiliary heater	HH2	○	○	○	○	○	○	£180.00
	THERMOTRONIC automatic climate control system. Includes: Rain sensor (JF1)	HH4	○	○	○	○	○	○	£2,105.00
	Ventilation system with filter	H81	○	○	○	○	○	○	£75.00
	Pre-installation for additional heat exchanger. Includes: Sliding door (T93) + Hot-water auxiliary heater (H12)	H88	○	○	○	○	○	○	£800.00
	Roof-mounted climate control system. Note: Only available with climate control system and RWD. Includes: Omission partition (D93) + Alternator 14 V / 250 A (M60) + TEMPMATIC semi-automatic climate control system (HH9)	HH7	○	-	○	-	○	-	£2,720.00
	Radio remote control for hot-water auxiliary heater. Includes: Hot-water auxiliary heater (H12)	HY1	○	○	○	○	○	○	£870.00
	Thermally insulated load/passenger compartment	H01	○	-	○	-	○	-	£295.00
	Auxiliary hot-air heater	H11	-	-	○	-	○	-	£1,295.00
	Auxiliary heat exchanger at the rear. Includes, deletion of sliding door (T93) and Heater booster (HZ9)	H13	○	-	○	-	○	-	£1,040.00
	Electric roof fan, vents load compartment	H72	○	-	○	-	○	-	£450.00

Category	Description	Option code	Front-wheel drive		Rear-wheel drive		All-wheel drive		List price, ex. VAT
			Van	Chassis cab / crewcab	Van	Chassis cab / crewcab	Van	Chassis cab / crewcab	
Interior storage	Hinged lid for centre stowage compartment	FJ1	●	●	●	●	●	●	£0.00
	Stowage compartment underneath cockpit	FJ4	●	●	●	●	●	●	£0.00
	Stowage net on driver's seat backrest	SZ7	○	○	○	○	○	○	£45.00
	Stowage net on co-driver's seat backrest	SZ8	○	○	○	○	○	○	£45.00
	Multifunction box on two-seater, stowable. Includes: Co-driver's double seat (S23)	Y2A	○	○	○	○	○	○	£385.00
	Hinged lid for stowage compartments left and right	FJ5	○	○	○	○	○	○	£95.00
	Shelf above windscreen	FF5	●	●	●	●	●	●	£0.00
	Mounting rails for roof rack	D13	○	-	○	-	○	-	£170.00
	Stowage compartment above roof panelling. Note: Only available for the Sprinter panel van with high roof (D03) or super-high roof (D05) and paint in vehicle colour (D06)	FF4	○	-	○	-	○	-	£150.00
	Internal roof rack (50 kg capacity)	D17	○		○		○		£440.00
	Pre-installation for switch panel	E3J	●	●	●	●	●	●	£0.00
	Coat hook in cab	F1K	○	-	○	-	○	-	£20.00
	Omission of stowage compartment under cockpit	F3W	-	-	○	○	○	○	£0.00
	Cup holder in passenger compartment	FF3	-	-	○	-	○	-	£75.00
	Single-size slot at front under roof liner	FF8	○	○	○	○	○	○	£65.00
	4 x Cup holders front	FG8	○	○	○	○	○	○	£0.00
Omission of shelf above windscreen	FW6	-	-	○	○	○	○	£0.00	
Keys	Two additional master keys	FZ9	○	○	○	○	○	○	£110.00
	Multi-button key	FY7	○	-	○	-	○	-	£30.00

Category	Description	Option code	Front-wheel drive		Rear-wheel drive		All-wheel drive		List price, ex. VAT
			Van	Chassis cab / crewcab	Van	Chassis cab / crewcab	Van	Chassis cab / crewcab	
Lighting	Extra indicator lamps, flat, on the roof at the rear	LB3	○	-	○	-	○	-	£115.00
	LED High Performance headlamps. Includes: Tail lamps with partial LED technology (L22)	LG7	○	○	○	○	-	-	£1,470.00
	Fog lamps with cornering light function	L13	○	○	○	○	○	○	£200.00
	Highbeam Assist	LA1	○	○	○	○	○	○	£265.00
	Courtesy lights	LB9	○	○	○	○	○	○	£70.00
	Tail lamps with partial LED technology Note: Only available as part of the LED High Performance headlamps (LG7)	L22	○	○	○	○	-	-	£1,470.00
	Headlight assistant	LA2	●	●	●	●	●	●	£0.00
	LED light strip in load compartment	LC2	○	-	○	-	○	-	£250.00
	Direction indicators on the side at the front. Includes: Exterior mirrors without indicators (FU5)	L44	○	○	○	○	●	●	£95.00
	Identification lamps	L49	○	○	○	○	○	○	£145.00
	Load compartment lighting with motion sensor	L71	○	-	○	-	○	-	£85.00
	Tail light wiring harness, extended	L76	-	○	-	○	-	○	£75.00
	Lights for left hand traffic	L10	●	●	●	●	●	●	£0.00
	Interior light(s), load/passenger compartment with door cont.	L65	●	-	●	-	●	-	£0.00
	Omission parking lamp	L94	○	●	○	●	○	●	£0.00
	Side marker lights	LB1	-	●	●	●	●	●	£0.00
	Preparation for side marker lights	LB2	-	○	-	○	-	○	£0.00
3rd brake light	LB5	●	-	●	-	●	-	£0.00	

Category	Description	Option code	Front-wheel drive		Rear-wheel drive		All-wheel drive		List price, ex. VAT
			Van	Chassis cab / crewcab	Van	Chassis cab / crewcab	Van	Chassis cab / crewcab	
Load-securing	Load-securing rails (2) fitted to floor L3 length of vehicle. Note: compatible cargo straps available from the Mercedes-Benz Accessory range.								
	For L1 panel van	VV2	○	-	○	-	-	-	£180.00
	For L2 panel van	VV2	○	-	○	-	○	-	£200.00
	For L3 panel van	VV2	-	-	○	-	○	-	£230.00
	For L4 panel van	VV2	-	-	○	-	○	-	£270.00
	Load-securing rails fitted at roof height inside load space. Note: compatible cargo straps available from the Mercedes-Benz Accessory range.								
	For L1 panel van	VC4	○	-	○	-	-	-	£180.00
	For L2 panel van	VC4	○	-	○	-	○	-	£200.00
	For L3 panel van	VC4	-	-	○	-	○	-	£230.00
	For L4 panel van	VC4	-	-	○	-	○	-	£270.00
	Load-securing rails fitted at waist height inside load space. Note: compatible cargo straps available from the Mercedes-Benz Accessory range. Rail not fitted to side load door.								
	For L1 van	V42	○	-	○	-	-	-	£180.00
	For L2 van	V42	○	-	○	-	○	-	£200.00
	For L3 van	V42	-	-	○	-	○	-	£240.00
	For L4 van	V42	-	-	○	-	○	-	£270.00
	Pallet support in sliding door step	V24	-	-	○	-	○	-	£95.00
	Weight supporting wheel arch	V52	○	-	○	-	○	-	£355.00
	Anchoring rail on either side wall, below the roof frame	VC4	○	-	○	-	○	-	£470.00
Load securing rail system	VV2	○	-	○	-	○	-	£200.00	

Category	Description	Option code	Front-wheel drive		Rear-wheel drive		All-wheel drive		List price, ex. VAT
			Van	Chassis cab / crewcab	Van	Chassis cab / crewcab	Van	Chassis cab / crewcab	
Load area	Half-height load compartment panelling	V25	○	-	○	-	○	-	£165.00
	Load space interior trim up to roof (wood)	VA2	○	-	○	-	○	-	£295.00
	Wood flooring	V43	●	-	●	-	●	-	£0.00
	Omission wooden floor	V93	○	-	○	-	○	-	£0.00
	Cable duct on side wall	V94	○	-	○	-	○	-	£30.00
	Cable duct on rear portal	V95	○	-	○	-	○	-	£30.00
	Load space interior trim up to roof (plastic)	VA3	○	-	○	-	○	-	£295.00
	Aluminium protective entrance strip for floor covering	VC5	○	-	○	-	○	-	£640.00
	Half-height load compartment panelling. Includes: Stowage compartment with net in rear doors (VA7) + Windows in liftgate/hinged rear-end doors (W61)	VA1	-	-	○	-	○	-	£750.00
	Plastic floor covering	VK8	○	-	○	-	○	-	£455.00
Mirrors	Exterior mirrors without indicators. Includes: Direction indicators on the side at the front (L44)	FU5	○	○	○	○	●	●	£95.00
	Side mirrors, heated and power-adjustable	F68	○	○	○	○	○	○	£170.00
	Rear-view mirror	F61	○	●	○	●	○	●	£0.00
	Extra long mirror bracket	FS2	-	○	-	○	-	○	£0.00
	Extended mirror bracket	FS1	-	○	-	○	-	●	£0.00
	Electrically foldable exterior mirrors, includes side mirrors, heated and power-adjustable (F68)	F64	○	○	○	○	○	○	£220.00
	Omission of extended mirror bracket	FA70	-	○	-	○	-	○	£0.00
Mud flaps	Front mud flaps	P47	○	○	○	○	○	○	£55.00
	Rear mud flaps	P48	○	-	○	-	○	-	£55.00
Paint	Optional colours solid or metallic finish.								
	For chassis cab	-	-	○	-	○	-	○	£565.00
	For panel van	-	○	-	○	-	○	-	£685.00
	Painted bumper: only in conjunction with one of the four paints: 7755/9197/9538/9775 And Radiator grille frame in vehicle colour (CN2) + Blind Spot Assist (JA7) + Parking Package with 360-degree camera (JB6) / Parking Package with reversing camera (JB7)	CM0	○	○	○	○	○	○	£2,870.00
Radiator grille frame in vehicle colour	CN2	○	○	○	○	○	○	£95.00	

Category	Description	Option code	Front-wheel drive		Rear-wheel drive		All-wheel drive		List price, ex. VAT
			Van	Chassis cab / crewcab	Van	Chassis cab / crewcab	Van	Chassis cab / crewcab	
Parking	Parking Package with 360-degree camera. Includes: Electrically foldable exterior mirrors (F64) + Exterior mirror heated and electrically adjustable (F68)	JB6	○	-	○	-	○	-	£1,445.00
	Parking Package with reversing camera	JB7	○	-	○	-	○	-	£905.00
Power Take Off	Engine front power take-off with bracket for additional alternator	N62	-	-	○	○	○	○	£285.00
	Engine power take-off at front with carrier for additional refrigerant compressor (RWD only)	N63	-	-	○	○	○	○	£285.00
	Constant engine speed control. Includes: Parameterizable special module (ED5)	M53	○	○	○	○	○	○	£485.00
	Variable electronic engine speed control. Includes: Parameterizable special module (ED5)	MT4	○	○	○	○	○	○	£530.00
	Power take off counter shaft MB, (2c)	N05	-	-	○	○	○	○	£915.00
	Power take off counter shaft MB, (2b)	N07	-	-	○	○	○	○	£1,035.00
	Transmission lock for power take-off. Includes: Power take off counter shaft MB, (2c) (N05) or power take off counter shaft MB, (2b) (N07)	N80	-	-	○	○	○	○	£1,150.00
	Pre-installation for transmission oil cooler. Includes: Power take off counter shaft MB, (2c) (N05) or power take off counter shaft MB, (2b) (N07)	GK4	-	-	○	○	○	○	£1,220.00
	ECO Gear 360 6-speed manual transmission	GD8	-	-	●	●	●	●	£0.00
Reverse camera	6-speed manual transmission	GE9	●	●	-	-	-	-	£0.00
Road speed limiters	Linear speed limiter 100 km/h	MD5	○	○	○	○	○	○	£70.00
	Linear speed limiter 120 km/h	MD3	○	○	○	○	○	○	£70.00
	Linear speed limiter 90 km/h	MD4	○	○	○	○	○	○	£70.00
	Speedometer, mph and km/h	J11	●	●	●	●	●	●	£0.00
	Speed limiter, 110 km/h	MK0	○	○	○	○	○	○	£130.00
	Speed limiter, 130 km/h	MK2	○	○	○	○	○	○	£130.00
High Roof	Standard on panel van L3 and L4	D03	○	-	○	-	○	-	£1,220.00
Super-high Roof	L3/L4 panel van - painted in MB 9147 arctic white	D05	○	-	○	-	○	-	£1,550.00
	L3/L4 panel van - painted in vehicle colour	D06	○	-	○	-	○	-	£2,110.00

Category	Description	Option code	Front-wheel drive		Rear-wheel drive		All-wheel drive		List price, ex. VAT
			Van	Chassis cab / crewcab	Van	Chassis cab / crewcab	Van	Chassis cab / crewcab	
Safety and driver assistance	Blind Spot Assist. Includes: Electrically foldable exterior mirrors (F64) + Exterior mirror heated and electrically adjustable (F68)	JA7	○	-	○	-	○	-	£640.00
	Crosswind Assist	JA8	●	●	●	●	●	●	£0.00
	Traffic Sign Assist. Includes: 3 years of free map updates (EX9) + Digital Owner's Manual (XO5) + Instrument cluster with colour display (JK5) + Navigation (E1E) + Live Traffic capability (E1G)	JA9	○	○	○	○	○	○	£1,105.00
	Active Lane Keeping Assist	JB4	○	○	○	○	○	○	£410.00
	ATTENTION ASSIST	JW8	●	●	●	●	●	●	£0.00
	Mercedes-Benz emergency call system	EY5	●	●	●	●	●	●	£0.00
	Breakdown management	EY6	●	●	●	●	●	●	£0.00
	Navigation. Includes: 3 years of free map updates (EX9) + Digital Owner's Manual (XO5) + Live Traffic capability (E1G)	E1E	○	○	○	○	○	○	£690.00
	Live Traffic capability (only available in conjunction with navigation)	E1G	○	○	○	○	○	○	£0.00
	Active Distance Assist DISTRONIC. Includes: Leather steering wheel (CL3) + Instrument cluster with colour display (JK5) + 7G-TRONIC PLUS (G42) + HOLD function (BH1)	ET4	○	○	○	○	○	○	£2,610.00
	Rain sensor	JF1	○	○	○	○	○	○	£105.00
	WET WIPER system. Includes: Rain sensor (JF1)	FM3	○	○	○	○	○	○	£105.00
	Cruise control	MS1	●	●	●	●	●	●	£0.00
	ECO start/stop function Note: Not available in conjunction with all-wheel drive. Includes: Alternator 14 V/200 A (M40)	MJ8	○	○	○	○	-	-	£270.00
	Seat belt reminder for co-driver seat	J55	○	○	○	○	○	○	£95.00
	Seat belt warning for driver's seat	J58	●	●	●	●	●	●	£0.00
	Outside temperature indicator	J65	●	●	●	●	●	●	£0.00
	Reversing warning device includes Switch-off (JW3)	JW0	○	○	○	○	○	○	£210.00
	Deactivation of bulb failure indicator	JW2	○	●	○	●	○	●	£0.00
	Lane Keeping Assist	JW5	○	○	○	○	○	○	£340.00
Incorrect fuelling protection system	K51	○	○	○	○	○	○	£50.00	

Category	Description	Option code	Front-wheel drive		Rear-wheel drive		All-wheel drive		List price, ex. VAT
			Van	Chassis cab / crewcab	Van	Chassis cab / crewcab	Van	Chassis cab / crewcab	
Safety and driver assistance	Comfort overhead control panel	LC4	●	●	●	●	●	●	£0.00
	Smoker package (Closable ashtray with cigarette lighter).	V85	○	○	○	○	○	○	£40.00
	First aid kit	Y10	○	○	○	○	○	○	£0.00
	Fire extinguisher	Y16	○	○	○	○	○	○	£105.00
	Warning triangle	Y44	○	○	○	○	○	○	£0.00
Security	Anti-theft protection package: Alarm protection for vehicle and cargo	FY1	●	●	●	●	●	●	£0.00
	Double locks	FY2	●	●	●	●	●	●	£0.00
	VIN visible from outside	XC8	●	●	●	●	●	●	£0.00
Seating	Armrest for driver's seat	S22	○	○	○	○	○	○	£50.00
	Armrest for co-driver's seat	S25	○	○	○	○	○	○	£45.00
	Comfort driver's seat	SB1	○	○	○	○	○	○	£110.00
	Comfort co-driver's seat	SB2	○	○	○	○	○	○	£110.00
	Convenience head restraint, driver's seat	SK0	○	○	○	○	○	○	£60.00
	Convenience head restraint, co-driver's seat	SK1	○	○	○	○	○	○	£60.00
	Suspension seat, comfort version, driver's seat. Note: Only available in conjunction with Driver's seat frame, low (S87)	SB3	○	○	○	○	○	○	£385.00
	Suspension seat, comfort version, co-driver's seat. Note: Only available in conjunction with Driver's seat frame, low (S87)	SB4	○	○	○	○	○	○	£385.00
	Co-driver's double seat	S23	●	●/○	●	●/○	●	●/○	£295.00
	Heated seat for driver	H16	○	○	○	○	○	○	£155.00
	Seat heating for co-driver. Includes: Heated seat for driver (H16)	H15	○	○	○	○	○	○	£310.00
	Seat belts orange, driver and co-driver	S62	○	○	○	○	○	○	£35.00
	Deletion of co-driver seat, seatbox and seatbelt system	S91, S99, SW1	○	○	○	○	○	○	£0.00
Deletion of passenger compartment seats, if crew cab	S92	-	○	-	○	-	○	-£90.00	
Armrest, driver's and co-driver's door	S28	○	○	○	○	○	○	£35.00	

Category	Description	Option code	Front-wheel drive		Rear-wheel drive		All-wheel drive		List price, ex. VAT
			Van	Chassis cab / crewcab	Van	Chassis cab / crewcab	Van	Chassis cab / crewcab	
Seating	Lumbar support, driver's seat. Includes: Comfort driver's seat (SB1)	SE5	○	○	○	○	○	○	£65.00
	Lumbar support, co-driver's seat. Includes: Comfort co-driver's seat (SB2)	SE4	○	○	○	○	○	○	£175.00
	Driver's seat electrically adjustable. Includes: Lumbar support, driver's seat (SE5) + Fabric Caluma black (VF4) + Heated seat for driver (H16)	SF1	○	○	○	○	○	○	£1,155.00
	Co-driver's seat electrically adjustable. Includes: Seat heating for co-driver (H15). Includes: Heated driver's seat electrically adjustable (SF1).	SF2	○	○	○	○	○	○	£2,250.00
	Driver's seat	S02	●	●	●	●	●	●	£0.00
	Adjustable co-driver's seat	S04	○	○/●	○	○/●	○	○/●	£0.00
	Comfort head restraints front passenger compartment seats	S31	-	-	○	-	○	-	From £185.00
	Re-enforced seat base	S86	-	○	-	○	-	○	£105.00
	Driver's seat plus	SB9	○	○	○	○	○	○	£25.00
Steering wheel	Steering wheel adjustable for height and tilt	CL1	●	●	●	●	●	●	£0.00
	Leather steering wheel and leather gearshift lever	CL2	○	○	○	○	○	○	£200.00
	Multifunction steering wheel	C6L	●	●	●	●	●	●	£0.00
	Leather steering wheel. Includes: 7G-TRONIC PLUS (G42) + HOLD function (BH1)	CL3	○	○	○	○	○	○	£1,675.00
Steps	Driver's seat plus	SB9	○	○	○	○	○	○	£25.00
	Rear door step	W73	○	-	○	-	○	-	£120.00
	Step, wide, at rear end	W75	○	-	○	-	○	-	£295.00
	Rear step sprung	W76	○	-	○	-	○	-	£500.00
	Cross member with integrated step	QA9	-	-	○	-	○	-	£335.00

Category	Description	Option code	Front-wheel drive		Rear-wheel drive		All-wheel drive		List price, ex. VAT
			Van	Chassis cab / crewcab	Van	Chassis cab / crewcab	Van	Chassis cab / crewcab	
Suspension	Various suspension packages are available, depending on application and variant.								
	Air suspension - run-on module 1 h. Note: Only available in conjunction with comfort suspension air suspension (CB2)	C1N	-	-	○	○	-	-	£165.00
	Air suspension for rescue vehicles. Note: Only available in conjunction with comfort suspension air suspension (CB2)	C1R	-	-	○	○	-	-	£90.00
	Air suspension - pre-installation for control switch in rear. Note: Only available in conjunction with comfort suspension air suspension (CB2)	C1V	-	-	○	○	-	-	£75.00
	Air suspension - actuation, speed signal. Note: Only available in conjunction with comfort suspension air suspension (CB2)	C2A	-	-	○	○	-	-	£90.00
	Air suspension - control switch in rear. Note: Only available in conjunction with comfort suspension air suspension (CB2)	C2H	-	-	○	-	-	-	£100.00
	Air suspension - control switch in instrument panel. Note: Only available in conjunction with comfort suspension air suspension (CB2)	C2I	-	-	○	○	-	-	£120.00
	Air suspension - valve for emergency filling. Note: Only available in conjunction with comfort suspension air suspension (CB2)	C2V	-	-	○	○	-	-	£115.00
	Shock absorbers reinforced	C47	○	○	○	○	-	-	£105.00
	Lateral protection	C57		○	-	○	-	○	£295.00
	Deletion, vehicle lowering Note: Only available for vehicles in the weight classes 3,000 kg and 3,500 kg with rear-wheel drive	CW2	○	○	○	○	-	-	£0.00
	Suspension for comfort and cargo protection	CB1	○	○	○	○	-	-	£320.00
	Comfort suspension, air suspension	CB2	-	-	○	○	-	-	£2,280.00
	Stabilisation level I Note: Not available for weight class 4,100 kg with front-wheel drive. Replaces CF2 to CF3 from previous Sprinter	CB7	○	○	○	○	-	-	£295.00
	Stabilisation level II, replaces CF4 and CF5 from previous Sprinter	CB8	○	○	○	○	-	-	£690.00
	Stabilisation, level III, intended for motorhome conversions	CB4	○	○	-	-	-	-	£595.00
	Vibration damper	CT1	-	-	○	○	○	○	£85.00

Category	Description	Option code	Front-wheel drive		Rear-wheel drive		All-wheel drive		List price, ex. VAT
			Van	Chassis cab / crewcab	Van	Chassis cab / crewcab	Van	Chassis cab / crewcab	
Tachograph	Omission tachograph Includes: Linear speed limiter 90 km/h EG (MD4) + Qualification N2 (Z2N) + Weight variant 3,550 kg (XG4) + Lane Keeping Assist (JW5)	J92	○	○	○	○	○	○	£0.00
	Tachograph pre-installation kit	JV6	○	○	○	○	○	○	£275.00
	EC digital tachograph with download capability Std over 3.5t	JD2	○	○	○	○	○	○	£690.00
	Tachograph 1 day/2 drivers, automatic (EC)	J19	○	○	○	○	○	○	£690.00
	Tachograph control under dashboard, co-driver side	J2B	○	○	○	○	○	○	£0.00
	Controls for tachograph at front under roof liner standard over 3.5t Note: Only in conjunction with Tachograph pre-installation kit (JV6)	H1B	●	●	●	●	●	●	£275.00
Towing equipment	Pre-installation for vehicle towing capacity up to 3,500 kg. Includes: Electrical components for trailer socket (E57) + Axle ratio i = 4,727 (AR5)	QA3	-	-	○	○	-	-	£300.00
	Trailer coupling for increased towing capacity 2.8 t/3.0 t. Includes: Electrical components for trailer socket (E57) + Axle ratio i = 4,182 (AR3)	QA8	-	-	○	○	○	○	£565.00
	Trailer coupling with fixed tow ball	Q22	○	○	○	○	○	○	£335.00
	Removable tow ball trailer coupling	Q50	○	○	○	○	○	○	£380.00
	Trailer coupling for increased towing capacity of 3.5 t. Includes: Electrical components for trailer socket (E57) + Axle ratio i = 4,727 (AR5)	QA7	-	-	○	○	-	-	£635.00
	Gross Combination Weight up to max. 8.0 t Note: Only available in conjunction with OM642 DE 30 LA v6 engine for vehicles with 5,000 kg or 5,500 kg gross vehicle weight rating	XP6	-	-	○	○	-	-	£0.00
	Gross Combination Weight up to max. 8.75 t	XP7	○	○	○	○	-	-	£0.00
	Trailer socket, 13-pin	E43	○	○	○	○	○	○	£140.00
	Pre-installation for vehicle towing capacity up to 2,800 kg. Includes: Electrical components for trailer socket (E57) + Axle ratio i = 4,182 (AR3)	QA5	-	-	○	○	○	○	£155.00
	Crossmember for trailer coupling	Q10	○	○	○	○	○	○	£230.00
	Towing eye rear	Q67	○	○	○	○	○	○	£15.00
	Trailer coupling with mouth 243/U 115	Q20	-	-	○	○	○	○	£490.00
Trailer coupling, 2.8 t trailer load, bolted	QA0	-	-	○	-	○	-	£1,015.00	

Category	Description	Option code	Front-wheel drive		Rear-wheel drive		All-wheel drive		List price, ex. VAT
			Van	Chassis cab / crewcab	Van	Chassis cab / crewcab	Van	Chassis cab / crewcab	
Trim	Luxury interior panelling. Includes: Stowage compartment with net in rear doors (VA7) + Windows in liftgate/hinged rear-end doors (W61)	V21	-	-	○	-	○	-	£750.00
	ARTICO man-made leather, black	VF6	○	○	○	○	○	○	From £55.00 depending on variant
	Caluma black fabric	VF4	○	○	○	○	○	○	From £55.00 depending on variant
	Maturin black fabric	VF7	●	●	●	●	●	●	£0.00
	Window pillar panelling Includes: Back pane heatable (H22) + Roof-mounted air conditioning system, basic (HH7) + Air conditioning, semi-automatically controlled, TEMPMATIC (HH9) + Alternator 14 V / 250 A (M60) + Range of parts, roof lining for bodybuilders (V08) + Panelling in load compartment up to belt rail standard (VA1) + Stowage compartment with net in rear doors (VA7) + Window front left, fixed, in sidewall/sliding door (W16) + Front right window fixed in side wall/sliding door (W17) + Fixed window at rear right (W28) + Fixed window, rear left (W27) + Window in tailgate/rear door with wipe/wash system (W78)	V31	-	-	○	-	○	-	From £4,980.00
Tyres	Tyres 195/75 R16 C	RH1	-	-	-	-	-	-	£0.00
	Tyres 205/75 R16 C	RG3	-	-	-	-	-	●	£0.00
	Tyres 225/65 R16 C	RN5	●	●	○	○	-	-	£0.00
	Tyres 225/75 R16 C	RG8	-	○	-	-	●	-	£0.00
	Tyres 235/65 R16 C	RH2	-	-	●	●	-	-	£0.00
	Tyres 235/60 R17 C	RH3	-	○	○	○	-	-	£0.00
	Make of tyres - Continental	RF1	○	○	○	○	●	●	£0.00
	Make of tyres - Pirelli (50)	RF5	○	○	○	○	-	-	£0.00
	Make of tyres - Michelin (80)	RF8	○	○	○	○	-	-	£0.00
	Make of tyres - Goodyear (90)	RF9	○	○	○	○	-	-	£0.00
	M&S tyres (mud and slush)	RM1	○	○	○	○	●	●	£195.00
	All-season tyres	RM0	○	○	○	○	-	-	£100.00
	Tyre pressure monitoring systems	RY2	○	○	○	○	○	○	£245.00
	Tyres without name of make	RD9	●	●	●	●	●	●	£0.00
	Summer tyres	RM7	●	●	●	●	-	-	£0.00
Tyres, resistance-optimised	RR0	●	●	●	●	-	-	£0.00	

● Standard ○ Optional - Not available

Category	Description	Option code	Front-wheel drive		Rear-wheel drive		All-wheel drive		List price, ex. VAT
			Van	Chassis cab / crewcab	Van	Chassis cab / crewcab	Van	Chassis cab / crewcab	
Wheels	Light alloy wheels 6.5 J x 16	RL5	○	○	○	○	○	○	£650.00
	Light alloy wheels 6.5 J x 17. Includes: Tyres 235/60 R17 C (RH3)	RL7	○	○	○	○	-	-	£715.00
	Steel wheels, arctic white	RM2	○	○	○	○	○	○	£60.00
	Light-alloy wheels, 6.5 J x 16, black	RM3	○	○	○	○	-	-	£755.00
	Full wheel cover	RD8	○	○	○	○	○	○	£95.00
	Spare wheel - Not available on 4t vehicles or Tractor heads	R87	●	●	●	●	●	●	£0.00
	Omission of spare wheel	R020	○	○	○	○	○	○	-£55.00
	Spare wheel bracket below frame end	R65	●	●	●	●	●	●	£0.00
	Steel wheels 6.5 J x 16	RS3	●	●	●	●	●	●	£0.00
	Jack	Y36	●	●	-	-	-	-	£0.00
	Hydraulic Jack	Y43	-	-	●	●	●	●	£0.00
Windows	Windscreen, heated. Includes: Air conditioning, semi-automatically controlled, TEMPMATIC (HH9)	F49	○	○	○	○	○	○	£1,330.00
	Rear wall window	F35	○	●	○	●	○	●	£110.00
	Fixed window at centre left Note: Only available for Tourer and panel vehicles with L3 and L4. Includes: Fixed window, rear left (W27)	W22	○	-	○	-	○	-	£120.00
	Fixed window, rear left. Includes: Fixed window at centre left (W22)	W27	○	-	○	-	○	-	£120.00
	Window front left, fixed, in sidewall/sliding door	W16	○	-	○	-	○	-	£120.00
	Fixed window, centre right Note: Only available for the Sprinter Tourer and panel van with L3 and L4. Includes: Fixed window at rear right (W28)	W23	-	-	○	-	○	-	£120.00
	Sliding window centre left Note: Only available for Tourer and panel van with L3 wheelbase (4,325 mm)	W24	○	-	○	-	○	-	£215.00
	Sliding window centre right. Note: Only available for panel van with L3 and L4	W25	-	-	-	-	-	-	£215.00
	Fixed window at rear right	W28	○	-	○	-	○	-	£120.00
Omission of window in cab rear wall	FB00	-	○	-	○	-	○	£0.00	

Category	Description	Option code	Front-wheel drive		Rear-wheel drive		All-wheel drive		List price, ex. VAT	
			Van	Chassis cab / crewcab	Van	Chassis cab / crewcab	Van	Chassis cab / crewcab		
Windows	Window fixed rear on the roof	D22	○	-	○	-	○	-	£470.00	
	Front right window fixed in side wall/sliding door	W17	○	-	○	-	○	-	£120.00	
	Window in liftgate/rear-end door with wiper/washer. Includes: Stowage compartment with net in rear doors (VA7) + Cable duct on rear portal (V95) + Back pane heatable (H22) + Cable duct on side wall (V94)	W78	○	-	○	-	○	-	£650.00	
	Back pane heatable. Includes: Windows in liftgate/hinged rear-end doors (W61) + Stowage compartment with net in rear doors (VA7)	H22	○	-	○	-	○	-	£495.00	
	Windows in liftgate/hinged rear-end doors. Includes: Stowage compartment with net in rear doors (VA7)	W61	○	-	○	-	○	-	£365.00	
	Sliding window in front left side wall/sliding door	W18	○	-	○	-	○	-	£240.00	
	Sliding window in front right side wall/sliding door	W19	○	-	○	-	○	-	£240.00	
	Heat-insulating glass with filter band on windscreen	H21	●	●	●	●	●	●	£0.00	
	Privacy glass tint in all windows fitted from B pillar backwards. Not available for L1 models.									
	For L3 / L4 Van and L2/L3 crewcab. Includes: Front right window fixed in side wall/sliding door (W17)	W70	○	○	○	○	○	○	£120.00	
	For L2 variants only. Includes: Front right window fixed in side wall/sliding door (W17)	W70	○	○	○	○	○	○	£120.00	
	Van with all-round panorama glazing	W02	-	-	○	-	○	-	£1,180.00	

Keeping Businesses Moving.

We don't just supply vans – we'll partner with you to deliver outstanding support and services to keep your vans on the road and your business moving.

- **Thousands of vehicle types** – Citan, Vito, X-Class and Sprinter vehicles are available in a range of height and length options and provide the ideal platform for bespoke conversions, because every business requirement is unique. Find out more at www.mbvans.co.uk
- **Free 24/7 roadside assistance*** – every single Mercedes-Benz Van comes with a lifetime promise to keep you moving, no matter what: MobiloVan – free dedicated roadside assistance for 30 years*. Find out more at www.mbvans.co.uk/mobilovan
- **Mercedes-Benz Finance** – we offer a range of flexible finance products to suit your business needs and keep your cash flow moving. Find out more at www.mbvans.co.uk/financeoffers
- **Affordable servicing plans** – we keep your working day moving. Over a third of our Dealer Network works through the night to service and maintain our customers' vans, so they're out on the road during the day, earning their keep. Because you don't stop, we don't either. We offer a range of servicing options to suit every business, every fleet, every van. Find out more at www.mbvans.co.uk/servicing
- **3-year unlimited mileage warranty** – all vehicles purchased from an authorised Mercedes-Benz Vans Dealer, if originally destined for the UK, receive our UK warranty. Find out more at www.mbvans.co.uk/warranties
- **Mercedes-Benz Insurance** – superb cover comes as standard including 7-day complimentary cover, and there are a range of Mercedes-Benz products after that to provide you with peace of mind. Find out more at www.mbvans.co.uk/insurance

*Terms and conditions apply – please visit mbvans.co.uk/mobilovan

› Locate a Dealer for more information, visit:
<https://forms.mercedes-benz.co.uk/VansBrochureTestDrive>
or book a test drive: www.mbvans.co.uk/dealerlocator

Please note: changes may have been made to the product since this brochure went to press (January 2019). The manufacturer reserves the right to make changes to the design, form, colour or specification during the delivery period, provided these changes, while taking into account the interests of the vendor, can be deemed reasonable with respect to the purchaser. Where the vendor or manufacturer uses symbols or numbers to describe an order or the subject of an order, no rights may be derived solely from these. The illustrations and descriptions may include accessories and items of optional equipment which are not part of standard specification. Colours may differ slightly from those shown in the brochure, owing to the limitations of the printing process. This brochure may also contain models and services which are not available in certain countries.

Storage of technical data in the vehicle: electronic vehicle components (e.g. airbag control unit, engine control unit etc.) incorporate data memory for technical vehicle data, such as alerts in the event of malfunction, vehicle speed, braking force or functionality of restraint and driving assistance systems in the event of an accident (audio and video data are not saved). These data are saved only fleetingly as a snapshot in time, e.g. in the event of a malfunction report; for a very short period of time (a few seconds at most), e.g. in the event of an accident; or in aggregated form, e.g. in order to assess component wear and tear. The saved data can be retrieved via interfaces within the vehicle. They may be processed and used by trained vehicle technicians as a means of diagnosing and addressing possible malfunctions, or by the manufacturer for analysis purposes and as a means of improving vehicle functions further.

If so requested by the customer, data may also provide the basis for further optional services. Transfer of the data from the vehicle to the manufacturer or third parties is only possible with appropriate legal authorisation (e.g. vehicle emergency call) or based on a contractual agreement with the customer and within the framework of data protection laws. Further information relating to the storage of data in the vehicle is provided in the Owner's Manual, a printed copy of which may be found in the vehicle, or online at the national Mercedes-Benz website.

Take-back of end-of-life vehicles. You can return your Sprinter to us for environment-friendly recycling in accordance with the European Union (EU) End-Of-Life Vehicles Directive. But that day lies a long way off. A network of vehicle take-back depots and dismantlers has been established to make it as easy as possible for you to return your vehicle. You can leave it at any of these points free of charge and, by so doing, make an important contribution to completing the recycling process and conserving resources. For further information about the recycling and disposal of end-of-life vehicles, and the take-back conditions, please visit your national Mercedes-Benz website.

