

Mercedes-Benz WebParts



Quick and easy online ordering. Keeping businesses moving.

Mercedes-Benz
Vans. Born to run.



Contents

Logging in	4
Welcome to your personalised homepage	5
Search for parts by VIN	6
Enter a product code	7
Special offers	8
Easy ordering	9
Manage your orders	10
Getting in touch	11

Keep your business moving with Mercedes-Benz WebParts.

- Order Mercedes-Benz GenuineParts around the clock
- See real-time availability and delivery details for each part
- Choose from the entire range of Mercedes-Benz GenuineParts, remanufactured parts and accessories
- Keep track of your Mercedes-Benz GenuineParts orders and download the data to support paperwork and planning
- Be confident you're ordering the right parts with our VIN function
- Save money with tailored and exclusive special offers

The entire Mercedes-Benz GenuineParts catalogue at your fingertips.

With 24-hour ordering on over 650,000 Mercedes-Benz GenuineParts, you can get Mercedes-Benz vans back on the road and back to business in no time.

And because Mercedes-Benz WebParts is personalised to your agreed terms with your preferred Dealer partner, you'll get up-to-date and accurate information on availability and price – plus exclusive, tailored offers.

What you'll need to get started:



A computer connected to the internet

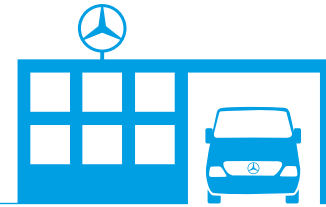

A Mercedes-Benz Dealer partner

Logging in.

To get started, visit **webparts.mercedes-benz.com** and enter your unique login details:



User ID:

Web password:

› Don't have any login details yet? Contact your Mercedes-Benz Dealer partner.

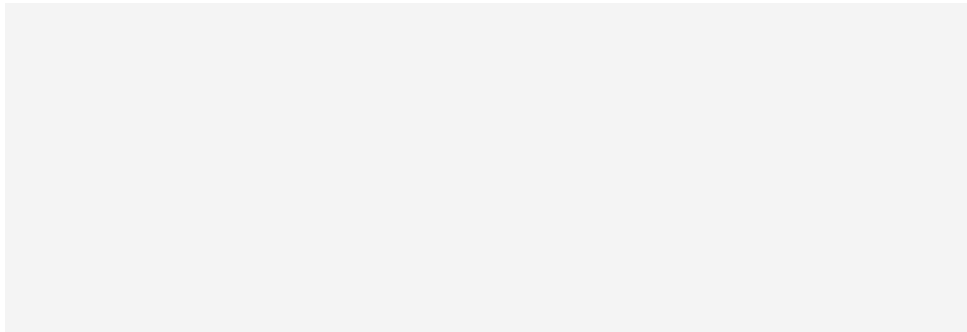

Welcome to your personalised homepage.

From here you'll easily be able to navigate your way around, finding the parts and information you need quickly.

- > Search for parts by model, VIN or product code
- > View current offers and check their status
- > Tailor your homepage with favourites, for even easier regular orders

The screenshot displays the Mercedes-Benz WebParts interface. At the top, there is a navigation bar with the Mercedes-Benz logo, 'WebParts Store', 'Order history', 'Your account', 'Dealer info', and 'Technical information'. Below this, a header area shows the user is signed in as 'CSUTESTE, Kunde DCUR CD, 48121 Test' and provides a mobile view indicator 'B / 3'. The main content area features a large banner with the text 'Welcome to Mercedes-Benz WebParts, your personal online ordering service'. Three primary navigation cards are visible: 'Specify by model' (with a search for VIN or model code and links to stored vehicles, EPC Web Edition, and BPC - Bus Parts Catalogue), 'Direct input' (with a search for part number and links to import list and template), and 'Offers' (highlighting a 'Van Service Kit Campaign 2016' and a 'Show all offers' link). Below the banner, a 'Quick start / personal favourites' section is divided into two columns: 'EPC browsing history' and 'Order history'. The EPC history lists three items related to a Mercedes-Benz van, and the order history shows three confirmed orders with their respective dates and amounts.

Mercedes-Benz WebParts

537-XX47120-01 - Daimler AG, HB DDLK D0 (Teststr. 47120, 47120 Test) (Standard)

Signed in as CSUTESTE, Kunde DCUR CD, 48121 Test | Help | Logout

Welcome to Mercedes-Benz WebParts,
your personal online ordering service

Specify by model

Direct input

Offers

Quick start / personal favourites

EPC browsing history

Order history

Van>120MXXK4X2 3200>>040 FRONT HEATER OR AIR CONDITIONING S...

Confirmed > Sep 21, 2016 > 16_-1002 > 886.09 GBP

Van>120MXXK4X2 3200>>135 AIR INTAKE, DIESEL VEHICLES

Confirmed > Sep 14, 2016 > 16_-1001 > 1,855.20 GBP

Van>120MXXK4X2 3200>>002 FRONT WHEEL BRAKE

Confirmed > Sep 7, 2016 > 16_-1000 > 42.00 GBP

Search for parts by VIN.

- › Enter your vehicle identification number (VIN) to make sure you're ordering the right part – reducing mistakes and saving time.
- › Simply search within the categories and subgroups, find the parts on the diagrams and check the price and availability.
- › Then add them to your shopping basket, to either buy them instantly or browse for any other parts you need.

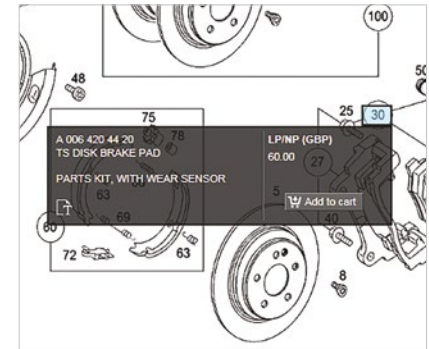
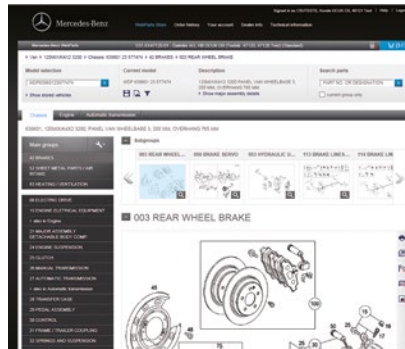

Enter a product code – or a few at once.

- If you know exactly what you want, simply enter a part number and order it immediately
- If you need specific parts on a regular basis, creating ‘order templates’ will save you time.

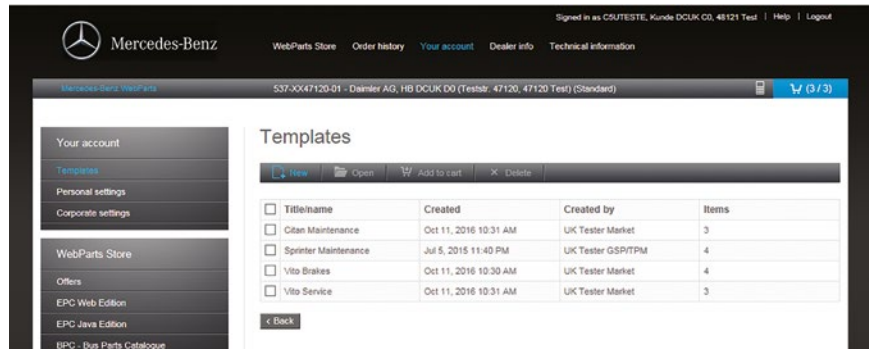
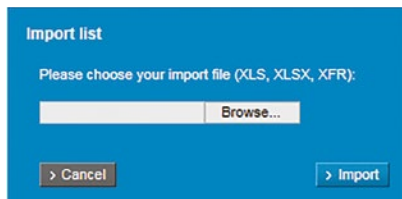

Special offers, tailored for you.

Because you're logged in to your own personal homepage, we'll tailor exclusive discounts and special offers to you and your business, that are appropriate to the Mercedes-Benz vans in your fleet.

These products are constantly being updated, so it's worth checking back regularly to see all the latest offers and find out how much you could save.



Van AdBlue Campaign

Mercedes-Benz AdBlue for vans. AdBlue engineered specifically to support Mercedes-Benz Sprinter, Vito and Citan vans.

Checking AdBlue levels is an essential part of the scheduled maintenance of your van and could contribute to lower exhaust emissions. Mercedes-Benz AdBlue is engineered specifically to support Mercedes-Benz BlueTEC technology, keeping your van's catalytic converter performing at its best.

[Download PDF document](#) [Download spreadsheet](#)

Validity period: Oct 10, 2016 - Jan 1, 2017
Order type: Stock order

		
ADBLUE 210 LITRE BARREL Part no.: A 004 989 04 20 13 210 Litre AdBlue Barrel	ADBLUE 20 LITRE CONTAINER Part no.: A 004 989 04 20 15 20 Litre AdBlue Container	ADBLUE 10 LITRE CONTAINER Part no.: A 004 989 04 20 12 10 Litre AdBlue Container
114.75 GBP List price 135.00 GBP Discount 15.00%	17.00 GBP List price 20.00 GBP Discount 15.00%	10.20 GBP List price 12.00 GBP Discount 15.00%
Add to cart	Add to cart	Add to cart

Easy ordering 24/7.

You've found your parts and they're in your shopping cart, now all you have to do is review the details, make any changes you need to and then place your order – specifying delivery details and including any extra instructions for your Mercedes-Benz Dealer partner.

The screenshot shows the Mercedes-Benz WebParts shopping cart interface. At the top, there is a navigation bar with the Mercedes-Benz logo, the text 'Mercedes-Benz', and links for 'WebParts Store', 'Order history', 'Your account', 'Dealer info', and 'Technical information'. The user is signed in as 'CSU/TESTE, Kunde DCUK CO, 48121 Test'. The main header of the cart page reads 'Shopping cart - standard view' and includes a 'Change view' dropdown set to 'Standard' and a 'Print' button. Below this is a search bar for 'Add part number' and buttons for 'Import list', 'Import from BPC', and 'Import from EPC Java Edition'. The cart is currently set to 'Order type: Stock order' and 'Delivery type: Collection'. A toolbar contains 'Select all', 'Clear selection', 'Order selected items', 'Save as template', 'Move', and 'Delete' options. The main table lists three items:

<input type="checkbox"/>	Part number	Designation	Pricing (GBP)	Quantity	Sum (GBP)
<input type="checkbox"/>	A 639 635 02 47 → Add remark	PARTICULATE FILTER ⓘ	LP/Net price	19.40 [- 1 + X]	19.40 incl. VAT: 23.28
<input type="checkbox"/>	A 000 180 49 09 → Add remark	639 VITO SERVICE KIT ⓘ	List price Discount (25.00%) Oct 10, 2016 - Jan 1, 2017 Net price	84.00 -21.00	63.00 incl. VAT: 75.60
<input type="checkbox"/>	A 639 420 02 01 → Add remark	TS BRAKE DISK ⓘ	LP/Net price	149.00 [- 1 + X]	149.00 incl. VAT: 178.60

Summary of prices (GBP):
Sum of list prices (GBP): 252.40
Discounts (GBP): -21.00
Total net price (GBP): 231.40
VAT (GBP): 46.28
Total price (GBP): 277.68

At the bottom, there is a 'Back' button, another 'Order type' and 'Delivery type' dropdown, and an 'Order all items' button. A 'Remarks and footnotes' section at the very bottom states: 'Prices may vary based on selected order type.'

Manage your orders.

The 'order history' function lets you to manage all your orders – both complete and in progress.

And to support your administrative team, everything can be exported to MS Excel or printed out, to help you keep track of your orders, plan your work and save you time.

Signed in as CSUTESTE, Kunde DCUK 00, 48121 Test | Help | Logout

Mercedes-Benz WebParts Store [Order history](#) [Your account](#) [Dealer info](#) [Technical information](#)

Mercedes-Benz WebParts 537-XX47120-01 - Diamler AG, HB DCUK 00 (Teststr. 47120, 47120 Test) (Standard) 0/0

Order history

Filter settings

Status **All** Year **Last 12 months** Month **Not specified**

Show Export Print Archive Delete

Order no.	Date	Your job number	Sum (GBP)	Delivery type	Status
<input type="checkbox"/> 16_-1003	Oct 11, 2016 11:02 AM	123457	302.66	Delivery	Ordered
<input type="checkbox"/> 16_-1002	Sep 21, 2016 3:02 PM		896.09	Collection	Confirmed
<input type="checkbox"/> 16_-1001	Sep 14, 2016 1:19 PM	123456	1,855.20	Collection	Confirmed
<input type="checkbox"/> 16_-1000	Sep 7, 2016 4:20 PM		42.00	Delivery	Confirmed

< Back

© 2004 - 2016 Mercedes-Benz UK Ltd. | Cookies | Privacy Policy | Legal Notice

Getting in touch.

Our quick and easy online service is backed by a dedicated team at your Dealer partner's, to make sure you get the support you need.

If you have any questions you can:

- > email mbukwebparts@daimler.com
or
- > contact your Mercedes-Benz Dealer partner – they can also help you with login details



Mercedes-Benz WebParts – keeps your business moving

Your personal online ordering service – quick, easy and convenient, 24 hours a day.

Visit **[mercedes-benz.com/webparts](https://www.mercedes-benz.com/webparts)**

Mercedes-Benz GenuineParts are for the purpose of reuse only and are not intended for resale.

Supplier: Mercedes-Benz UK, Tongwell, Milton Keynes MK15 8BA