

Mercedes-Benz

eVITO.

Electric Panel Van model.

Prices effective from May 2026





RETURN TO START

## Contents

> <b>Summary</b>	<b>3</b>
> <b>Enhanced safety</b>	<b>4</b>
> <b>Standard equipment highlights</b>	
The eVito PRO	<b>5</b>
The eVito SELECT	<b>6</b>
> <b>List price summary</b>	<b>7</b>
> <b>Mercedes-Benz finance options</b>	<b>8</b>
> <b>Equipment</b>	<b>9</b>
> <b>Colours and upholstery</b>	<b>12</b>
> <b>Charging information</b>	<b>13</b>
> <b>Technical data</b>	<b>14</b>
> <b>Mercedes-Benz Vans and the environment</b>	<b>18</b>
> <b>The Mercedes-Benz App</b>	<b>19</b>
> <b>Approved used</b>	<b>20</b>
> <b>Integrated Service Package (ISP)</b>	<b>21</b>
> <b>Service 24: Demand more</b>	<b>22</b>

### Please note

This document provides information about the model range line-up and specifications of the eVito Panel Van. It also contains key details about options, economy and performance of all variants. Details are correct at time of publication and are subject to revision without notice. Any images used in this document may not reflect UK specification and are for illustrative purposes only. Images may show optional equipment which does not form part of UK standard specification. Pricing in this price list applies to 60kWh models only.

# The New eVito Summary.



RETURN TO START

1 vehicle model:	Panel van (2-3 seats)
1 charging configuration:	AC: 11kW/DC: 80kW**
2 vehicle lengths:	L2 or L3
2 trim levels:	PRO or SELECT

All-electric WLTP combined range, full charge  
159 - 160 miles

80% charge top-up in just  
35 minutes

Class-leading  
Safety and Connectivity



eVito PRO



eVito SELECT

Combined WLTP range for the eVito 60kWh Panel Van range in miles (km): 159 (256) - 160 (257). Combined energy consumption in kWh/100 km: 26.4 - 26.5. Combined CO<sub>2</sub> emissions in g/km: 0. Figures correct as of April 2025. The indicated values were determined according to the prescribed measurement method - Worldwide Harmonised Light Vehicle Test Procedure (WLTP). Battery Electric Vehicles (BEV) require mains electricity for charging, range figures determined with the battery fully charged. Figures shown are for comparability purposes; only compare with other cars tested to the same technical procedure (WLTP). Figures may not reflect real life driving results, which will depend upon a number of factors including the starting charge of the battery, factory-fitted options, accessories fitted (post registration), variations in weather, driving styles and vehicle load. Further information about the test used to establish range, power consumption and CO<sub>2</sub> figures can be found at <http://www.mercedes-benz.co.uk/WLTP>. For real time data visit [https://voc.mercedes-benz.com/voc/gb\\_en](https://voc.mercedes-benz.com/voc/gb_en). \*\*Charging times are subject to the power available at the location where the vehicle will be charged as well as external factors such as temperature and type of cable and charger used.

# Enhanced Safety.



RETURN TO START

The eVito is based on a sophisticated safety concept. Active driving assistance and safety systems offer useful functions to support the driver. A significantly expanded standard range of assistance systems is available.

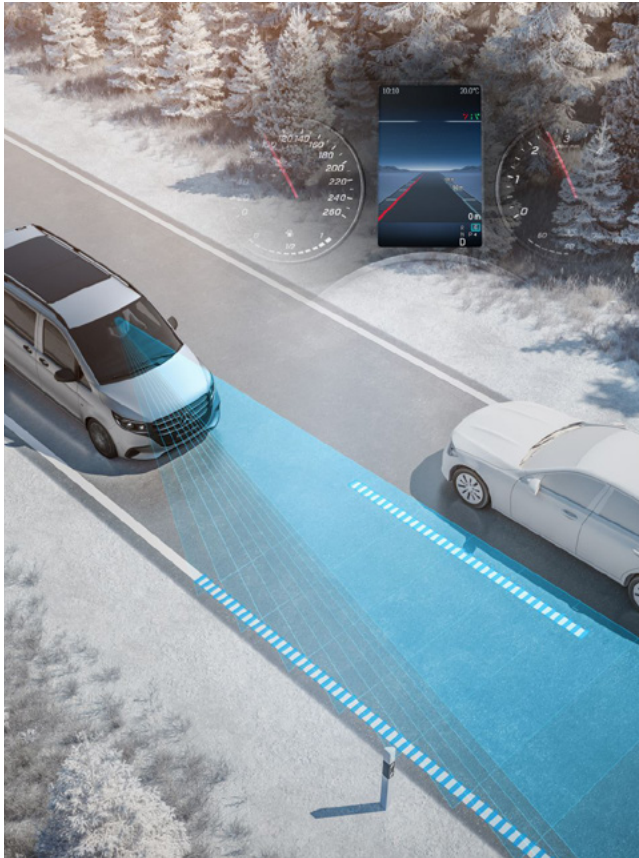

## Active Lane Keeping Assist (JB4)

Protects against unintentional lane departure. If the system's camera detects a lane departure, a corrective steering intervention takes place to guide the vehicle back into the lane. If the driver fails to react and the vehicle crosses the lane markings, an additional haptic warning occurs (pulsed vibration via the steering wheel).

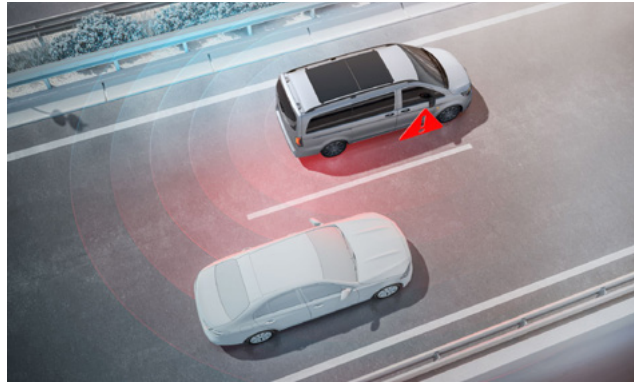

## Blind Spot Assist (JA7)

Helps when changing lanes and reversing. If a vehicle is detected, a warning sign in a red triangle appears in the corresponding exterior mirror.



## Intelligent Speed Assist (JS2)

Displays the current speed limit in the driver's direct field of vision in the instrument cluster.



## ATTENTION ASSIST (JW8)

Can help to avoid momentary nodding off and therefore provides you with increased safety, in particular when driving at night and on long journeys. The system provides you with a visual and audible warning if it identifies typical signs of fatigue or attention lapses, and suggests taking a break.

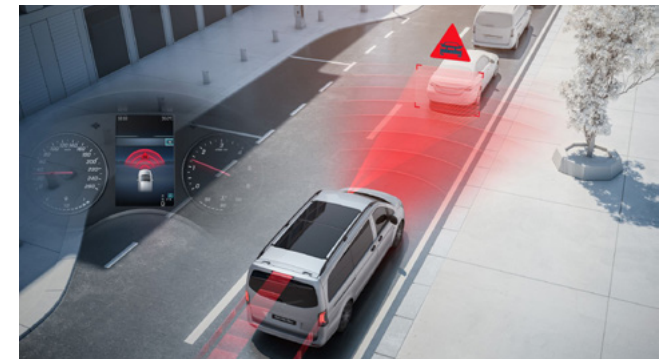

## Active Brake Assist (BA3)

With pedestrian and cyclist detection. The system helps to prevent rear-end collisions. Active Brake Assist can help you to prevent accidents (with vehicles driving in front, with crossing pedestrians or cyclists) or to minimise their consequences.

# The eVito Van PRO.



RETURN TO START

Standard features include:

## Exterior

- Black-grain bumpers, front and rear
- 17-inch steel wheels
- Adaptive brake lights
- Heated and electrically adjustable door mirrors
- Summer tyres

## Interior

- MBUX Multimedia System with 10.25" Touchscreen
- Instrument cluster with 5.5" TFT colour display
- Double co-driver seat (L2 only)
- TEMPMATIC air conditioning
- Heated driver's seat
- Comfort driver's seat
- Adjustable steering wheel, reach and rake
- Multifunction steering wheel
- Comfort over-head control panel

## Load area

- Rear 'barn' style doors, 180° opening
- Twin side loading doors
- Full-height steel bulkhead
- TPO plastic flooring
- Side panelling in load area
- Weldnuts in sidewall for conversions

## Technology

- AC Type 2 charging, max. 11kW/DC CCS charging, max. 80kW
- Electrical strip for electrical consumables
- 2-way loudspeakers, front
- Digital Extra: Smartphone Integration
- Pre-entry climate control

## Safety and Driver Assistance Systems

- Reverse camera
- Active Brake Assist with pedestrian detection
- ATTENTION ASSIST
- Headlight assistant
- Tyre pressure monitoring
- Emergency call system
- Airbags, driver and co-driver
- Blind spot assist
- Intelligent speed assist
- Cruise control
- Alarm and double locks
- Driver camera



Basic recommended list price (ex.VAT) for the eVito PRO L2

£48,775

➤ [Arrange a test drive at your nearest Dealership](#)

\* Vehicle purchase price is calculated on base vehicle only (excluding any optional equipment), it excludes delivery charges and first registration fee. The grant will be applied after any vehicle discount has been offered and includes VAT and number plate costs. For more information, visit: <https://www.gov.uk/plug-in-car-van-grants>

# The eVito Van SELECT.



RETURN TO START

Upgrade from PRO to SELECT to get all of the additional equipment listed below:

## Exterior

- 17" Light-alloy wheels, 5-twin spoke design
- Electrically foldable exterior mirrors
- Painted bumpers
- Metallic paint
- Chromed radiator grille

## Interior

- Velour floor mats
- Lumbar support for driver's seat
- Leather steering wheel

## Safety and Driver Assistance Systems

- Parking package with 360 degree camera



Basic recommended list price (ex.VAT) for the eVito SELECT L2

£52,160

➤ **Arrange a test drive at your nearest Dealership**

\* Vehicle purchase price is calculated on base vehicle only (excluding any optional equipment), it excludes delivery charges and first registration fee. The grant will be applied after any vehicle discount has been offered and includes VAT and number plate costs. For more information, visit: <https://www.gov.uk/plug-in-car-van-grants>

# List Price Summary.



RETURN TO START

Vehicle Model Description	Powertrain	CO <sub>2</sub> emissions, WLTP	Basic Recommended Retail Price (Ex. VAT)	Total Recommended Retail Price (Inc. VAT)
eVito Van PRO L2	Battery electric vehicle, 116PS/85kW, FWD, single-speed automatic transmission Electric range 159 miles WLTP combined	0g/km	£48,775	£58,530
eVito Van PRO L3	Battery electric vehicle, 116PS/85kW, FWD, single-speed automatic transmission Electric range 160 miles WLTP combined	0g/km	£49,495	£59,394
eVito Van SELECT L2	Battery electric vehicle, 116PS/85kW, FWD, single-speed automatic transmission Electric range 159 miles WLTP combined	0g/km	£52,160	£62,592

## Government OZEV grant of up to £5,000

The eVito is eligible for a Government OZEV grant that gives businesses 35% off the purchase price, up to a maximum of £5,000\*.



## Carbon Neutral Production

All Mercedes-Benz Vans and Cars, including the eVito, will benefit from carbon-neutral production starting from January 2022.

\* Vehicle purchase price is calculated on base vehicle only (excluding any optional equipment), it excludes delivery charges and first registration fee. The grant will be applied after any vehicle discount has been offered and includes VAT and number plate costs. For more information, visit: <https://www.gov.uk/plug-in-car-van-grants>

This document is for guidance only and must be used in conjunction with a configuration tool prior to final specification decisions and vehicle quotations being prepared and accepted. List prices are quoted ex-factory unless otherwise stated. Delivery charges excluding VAT will be added to model prices quoted in this document. Prices based on standard finish paint choice. Mercedes-Benz Vans UK and authorised Dealers reserve the right to alter specification and vary prices without notice. The availability of options may depend on the chosen base vehicle and other optional equipment specified, and should be confirmed with your Mercedes-Benz Vans Dealer prior to order placement. VAT is calculated at the standard rate of 20%. Mercedes-Benz Vans UK Ltd, Tongwell, Milton Keynes MK15 8BA.



RETURN TO START

# Mercedes-Benz Finance Options.

## Choose an agreement that suits you with Mercedes-Benz Finance.

At Mercedes-Benz Finance we understand what it takes to run a modern-day business. Because of this, we have a number of finance options ready to suit your business needs.

### Agility (Personal Contract Plan)

Agility (Personal Contract Plan) is our most flexible method of financing. You drive the vehicle over a fixed term, with fixed monthly payments. And at the end of the agreement, you decide whether you want to:

- Buy another Mercedes-Benz.
- Purchase your van by paying the Optional Purchase payment (balloon) and Option to Purchase Fee.
- Return it to us.

As a business customer, your vehicle can also appear as an asset on your balance sheet.

[For more information about Agility.](#)

### Hire Purchase

A straightforward route to ownership. This product allows you to spread the overall cost of your Mercedes-Benz over a fixed term.

As a business customer, your vehicle can also appear as an asset on your balance sheet.

[For more information on Hire Purchase.](#)

### Operating Lease

A solution for those who want to drive one of our vehicles over a specific term, with fixed monthly rentals and without the commitment of ownership of the vehicle.

As a business customer, your vehicle can also appear as an asset on your balance sheet.

[For more information on Operating Lease.](#)

### Contract Hire

A solution for those who want to drive one of our vans over a specific term, with fixed monthly rentals and without the need to commit to ownership of the vehicle. This includes the cost of your Vehicle Excise Duty (also known as Road Fund Licence) for the duration of your agreement.

As a business customer, your vehicle can also appear as an asset on your balance sheet.

[For more information on Contract Hire.](#)

### Finance Lease

Finance Lease gives you the ability to enjoy driving a Mercedes-Benz Van for a fixed time without the option of ownership. With this option you lease your vehicle for a fixed period and for fixed monthly rentals.

As a limited company or PLC customer, your vehicle can also appear as an asset on your balance sheet.

[For more information on Finance Lease.](#)

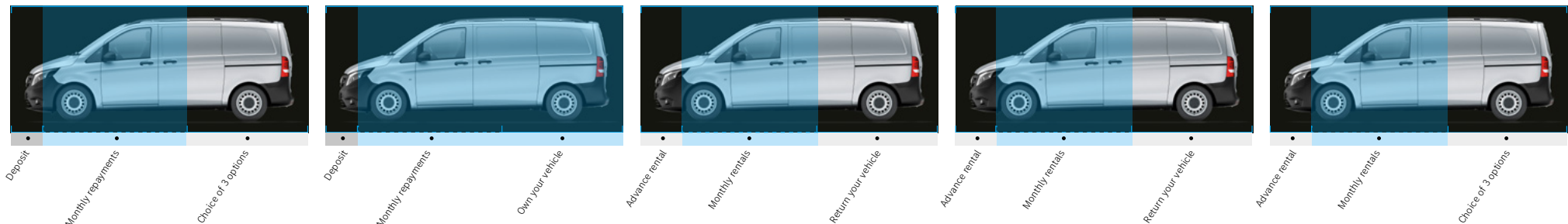

[For more information about our finance options](#)

# Equipment.



RETURN TO START

Key: ● Standard ○ Optional ◇ Equipment dependant option available — Not available

Category	Option Description	Option code	PRO	SELECT	Basic Price exc. VAT	Basic Price inc. VAT
Audio Entertainment and Nav	<b>MBUX Multimedia System</b>	E7M	●	●	—	—
	<b>Digital Extra: Smartphone Integration</b> Required for Android Auto and Apple CarPlay. (Requires pairing of the vehicle with a Mercedes-Benz ID).	E4S	●	●	—	—
	<b>Digital Extra: Hard-disc navigation</b>	E1E	○	○	£900.00	£1,080.00
Heating and Ventilation	<b>Heated seat for driver seat</b>	H16	●	●	—	—
	<b>Heating for co-drivers seat</b>	H15	○	○	£265.00	£318.00
	<b>TEMPMATIC air conditioning</b> Cools and dehumidifies the air. Features a particulate filter to remove particles of dust and pollen from the outside air.	HH9	●	●	—	—
	<b>THERMOTRONIC automatic climate control</b> Automatically controls temperature, airflow and air distribution in 2 separate climate zones. If outside temperatures are very low, the residual heat mode (REST) can make use of the heat stored in the coolant circuit for up to 30mins after the motor has been switched off.	HH4	○	○	£810.00	£972.00
Steering wheel	<b>Leather steering wheel</b>	CL3	○	●	£225.00	£270.00
	<b>Steering wheel heating</b>	CK8	○	○	£280.00	£336.00
Keys	<b>Two additional master keys</b>	FZ9	○	○	£175.00	£210.00
Seating	<b>Comfort driver's seat</b> Single armrest on the side facing the front passenger; fore/aft adjustment (225mm in total, with 4.5mm intervals); stepless adjustment of the seat backrest angle; stepless seat height adjustment; comfort head restraint adjustable for angle and height.	SB1	●	●	—	—
	<b>Co-driver's double seat</b> (Not available on L3)	S23	●	●	—	—
	<b>Co-driver's seat, standard</b> (Standard on L3)	S09	●	○	£0.00	£0.00
	<b>Comfort co-driver's seat</b> Co-driver seat with inboard armrests and 4-way adjustable headrests. This deletes the double co-driver seat and therefore limits the cab area to two occupants.	SB2	○	○	£210.00	£252.00
	<b>Driver's seat electrically adjustable</b>	SF1	○	○	£1,485.00	£1,782.00
	<b>Co-driver's seat electrically adjustable</b>	SF2	○	○	£1,485.00	£1,782.00
	<b>Black, man-made-leather seat upholstery</b> The black, man-made leather lends the interior a comfortable aspect and impresses with its low-maintenance and high-comfort surface.	VU9	○	○	£90.00	£108.00

● Standard ○ Optional ◇ Equipment dependant option available — Not available

Changes to individual option availability and combinations may occur depending on vehicle specification choices and the continuing evolution and adaptation of our product range. These changes may not be immediately reflected in this document as they occur, but will be introduced at the next revision opportunity.

# Equipment.



RETURN TO START

Category	Option Description	Option code	PRO	SELECT	Basic Price exc. VAT	Basic Price inc. VAT
Lighting	<b>MULTIBEAM LED with Highbeam Assist PLUS</b>	L45	○	○	£2,330.00	£2,796.00
	<b>Interior ambient lighting</b>	LP1	○	○	£315.00	£378.00
	<b>LED tail lamps, brake lamps and indicators</b> Only in conjunction with W65 Tailgate.	LG4	○	○	£0.00	£0.00
	<b>LED lightstrip</b>	LC2	○	○	£125.00	£150.00
Safety and driver assistance	<b>Blind Spot Assist</b>	JA7	●	●	—	—
	<b>Intelligent Speed Assist</b>	JS2	●	●	—	—
	<b>Traffic Sign Assist</b>	JA9	○	○	£0.00	£0.00
	<b>Driving Assistance package</b> Includes new features: Route based speed adjustment (JM3); Extended automatic start-up on motorways (JM2) and Active speed limit assist (JM4)	JS3	○	○	£1,210.00	£1,452.00
	<b>Active Distance Assist DISTRONIC</b>	ET4	○	○	£1,140.00	£1,368.00
	<b>Driver camera</b>	JK8	●	●	—	—
	<b>Reversing camera</b>	FR8	●	—	—	—
	<b>Parking package with 360° camera</b>	JB6	○	●	£1,880.00	£2,256.00
	<b>Parking package with reversing camera</b>	JB7	○	—	£1,300.00	£1,560.00
	<b>PRESAFE</b> The PRE-SAFE® anticipatory occupant protection system can detect critical driving situations at an early stage and initiate preventive protection measures.	JP1	○	○	£455.00	£546.00
	<b>First aid kit</b>	Y10	○	○	£65.00	£78.00
	<b>Warning triangle</b>	Y44	○	○	£50.00	£60.00
Airbags	<b>Driver thorax-pelvis sidebag</b>	SH1	●	●	—	—
	<b>Co-driver thorax-pelvis sidebag</b>	SH2	●	●	—	—
Flooring	<b>Velour floor mats</b> The black velour floor mats visually enhance the cockpit.	VL2	○	●	£65.00	£78.00
Doors	<b>Double-wing rear doors, 180 degrees, w/o window</b>	W50	●	●	—	—
	<b>Tailgate</b>	W65	○	○	£0.00	£0.00
Roof options and bodywork	<b>Roof rails</b> Maximum load of 150kg, when supported by three carrier bars.	D12	○	○	£505.00	£606.00
	<b>Chrome radiator grille</b> Only available in conjunction with painted bumpers (CM2).	FK2	○	●	£175.00	£210.00

● Standard ○ Optional ◇ Equipment dependant option available — Not available

Changes to individual option availability and combinations may occur depending on vehicle specification choices and the continuing evolution and adaptation of our product range. These changes may not be immediately reflected in this document as they occur, but will be introduced at the next revision opportunity.

# Equipment.



RETURN TO START

Category	Option Description	Option code	PRO	SELECT	Basic Price exc. VAT	Basic Price inc. VAT
Tyres	<b>Spare wheel with Jack</b>	RR6	○	○	£215.00	£258.00
	<b>All-season tyres</b> Compared to summer tyres, all-season tyres excel with better traction in wintry road conditions	RM0	○	○	£225.00	£270.00
	<b>Mud and slush tyres</b> The M+S tyres can improve traction and lateral support in wintry road conditions, improving driving safety on snow, ice and mud.	RM1	○	○	£210.00	£252.00
Wheels	<b>17" steel wheels</b> Wheel: 6.5 J x 17 ET 51 Tyres: 225/55 R17	R17	○	○	£0.00	£0.00
	<b>17" Alloy wheels (5 twin-spoke design)</b> Wheel: 7 J x 17 ET 51 Tyres: 225/55 R17 or 235/55 R17	R1N	○	●	£840.00	£1,008.00
	<b>17" Alloy wheels (20 spoke design) painted in vanadium silver</b> Wheel: 7 J x 17 ET 51 Tyres: 225/55 R17	RK8	○	○	£840.00	£1,008.00
Paint	<b>Metallic Paint</b>	n/a	○	●	Varies by colour	Varies by colour
	<b>Bumpers/detachable body parts painted body colour</b>	CM2	○	●	£440.00	£528.00
Speedlimiter	<b>Road speed limiter 80km/h (50mph)</b>	MK5	○	○	£0.00	£0.00
GVW	<b>Upated GVW rating 3.2t</b>	XA5	●	●	—	—
Electrical	<b>Parameterizable special module</b>	ED5	○	○	£520.00	£624.00
	<b>Terminal strip for electrical connection</b>	EK1	●	●	—	—
Packages	<b>Mirror package</b> The Vito Mirror package uses automatically dimming mirrors and electrically folding outside mirrors to increase the driving comfort and driving safety.	FP2	○	○	£455.00	£546.00
	<b>Chrome interior appointments package</b> The Chrome interior package further enhances the look of the driver's and front-passenger area with its trim elements on the dashboard and in the front doors.	FP4	○	○	£175.00	£210.00
	<b>Maintenance package</b> This package includes regular maintenance work and the inspection of important high-voltage components, other vehicle parts and functions during the first 4 years.	JE1	●	●	—	—

● Standard ○ Optional ◇ Equipment dependant option available — Not available

Changes to individual option availability and combinations may occur depending on vehicle specification choices and the continuing evolution and adaptation of our product range. These changes may not be immediately reflected in this document as they occur, but will be introduced at the next revision opportunity.

# Colours and upholstery.



RETURN TO START

## Solid paints



Arctic White  
(Standard for PRO)

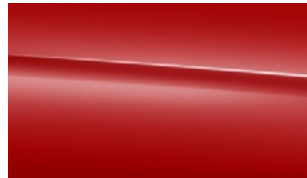

Jupiter Red



Steel Blue

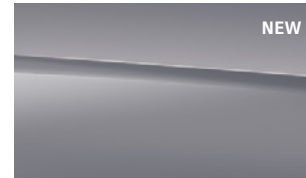

Alpine Grey



Vintage Blue

## Metallic paints

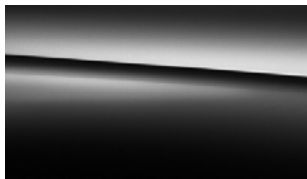

Obsidian Black



Hightech Silver



Graphite Grey

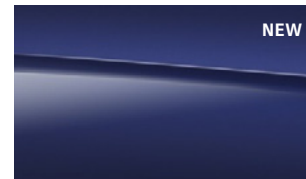

Sodalite Blue

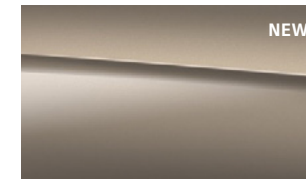

Kalahari Gold



Hyacinth Red

## Interior upholstery



Black Caluma seat upholstery  
(Standard)

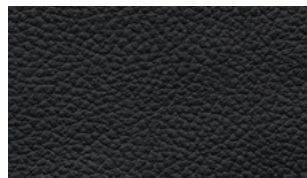

Black leatherette seat upholstery  
(Optional)

Due to limitations of on-screen representation, the vehicle colours may differ in reality to the on screen images.

# Charging Information.

## Increasing efficiency and reducing downtime.

### > The eVito can be charged by Direct Current (DC) or Alternating Current (AC).

AC is usually found at homes and workplaces and more cost effective for charging, however, generally requires longer intervals to fully charge. DC power can rapid-charge an electric vehicle using higher charging powers. For example, the eVito can accept 80kW of power.

- AC 11kW 0-100% in ~6.5 hours†
- DC 80kW 10-80% in just 35 minutes†.

### > Managing range and battery performance.

The eVito uses a process called recuperation that recovers energy when the vehicle is decelerating to help recharge the vehicle's battery. There are 5 recuperation modes available, which can be adjusted via the steering-wheel paddles. The greater the recuperation level, the faster you decelerate and therefore, the more energy your vehicle will recover. An automatic mode is also fitted as standard, which uses the radar-sensor to intelligently select the best mode for a given driving situation.

- D-** This mode will enable you to get maximum range from your eVito. It has maximum recuperation and fastest deceleration. Due to the deceleration being so strong, your vehicle will automatically activate your brake lights when you lift off the accelerator.
- D** This mode has less recuperation than D- and has similar deceleration levels to a diesel Vito.
- D+/D++** This mode has significantly lower recuperation levels and therefore will decelerate at a slower rate than a diesel Vito. D++ is a coasting mode, meaning your vehicle will have no recuperation and can 'sail' for example when driving for long periods downhill.
- D<sup>AUTO</sup>** This mode uses the radar-sensor to switch between the best mode for the situation and offers an easy solution for those who want maximum efficiency and highest comfort levels.

† Charging times are subject to the power available at the location where the vehicle will be charged as well as factors such as temperature, charge point and type of cable used.

^ Mercedes-Benz research analysed 1.6 million journeys anonymously on the EQ Ready app and 96% of all journeys recorded were shorter than 100km (62 miles).



Did you know the average van across the UK and Europe travels less than 62 miles<sup>^</sup> a day?



The Mercedes-Benz eVito

13

# Technical Data – Battery and e-Motor.



RETURN TO START

## System specifications

Fuel	Electricity
e-Motor	3-phase, 6-pole asynchronous induction
Output, peak**	116PS (85kW)
Output, long-run**	95PS (70kW)
Drive	Front-wheel drive
Battery composition	Lithium-ion
Battery capacity, installed	66kWh
Battery capacity, usable	60kWh
System voltage, nominal	400V

## Charging specifications

Max. Charging capacity, AC	11 kW
Charging time, AC at 11kW, 0-100%	6 hours 30 minutes†
Max. Charging capacity, DC	80kW
Charging time, DC at 80kW, 10-80%	35 minutes†
Charging cable supplied with vehicle	Type 2, mode 3, 32A, 8m

† Charging times are subject to the power available at the location where the vehicle will be charged as well as factors such as temperature, charge point and type of cable used.

\*\*Power available will be reduced in stages by the vehicle when the battery is at ~7% state-of-charge.



[RETURN TO START](#)

# Technical Data – WLTP Range and Electrical Consumption.

Range, WLTP (km/miles)	Combined (km/miles)	Low to Medium (km/miles)			
eVito Van PRO L2	256/159	311/193			
eVito Van PRO L3	257/160	311/193			
eVito Van SELECT L2	256/159	310/193			
Electrical consumption (kWh/100km)	Combined	Low to Medium	Medium (urban)	High (rural)	Extra-high (motorway)
eVito Van PRO L2	26.4	20.5	21.3	23.8	34.2
eVito Van PRO L3	26.4	20.5	21.2	23.7	34.2
eVito Van SELECT L2	26.5	20.6	21.3	23.8	34.3

The indicated values were determined according to the prescribed measurement method – Worldwide Harmonised Light Vehicle Test Procedure (WLTP). Battery Electric Vehicles (BEV) require mains electricity for charging, range figures determined with the battery fully charged. Figures shown are for comparability purposes; only compare with other cars tested to the same technical procedure (WLTP). Figures may not reflect real life driving results, which will depend upon a number of factors including the starting charge of the battery, factory-fitted options, accessories fitted (post registration), variations in weather, driving styles and vehicle load. Further information about the test used to establish range, power consumption and CO<sub>2</sub> figures can be found at <http://www.mercedes-benz.co.uk/WLTP>. For real time data visit [https://voc.mercedes-benz.com/voc/gb\\_en](https://voc.mercedes-benz.com/voc/gb_en).

# Technical Data – Payload and Weights.

Model	Gross vehicle weight, kg	Kerb weight, with driver (75kg), kg	Payload, kg	Towing capacity, braked/unbraked, kg
eVito Van PRO L2	3200	2407	793	0/0
eVito Van PRO L3	3200	2406	794	0/0
eVito Van SELECT L2	3200	2417	783	0/0

All weights and dimensions quoted are subject to normal manufacturing tolerances of +/- 5%. Stated weight figures in accordance with Directive 97/27/EC in the applicable version at the time of going to print. Stated weight figures are for UK supplied vehicles and include charging cable and all standard equipment. The figures are not based on an individual vehicle and do not constitute part of the product offer; they are provided solely for the purposes of comparison between different vehicle models. The payload figures depend on the optional equipment fitted to the vehicle, please contact your Mercedes-Benz Retail Partner for an individual vehicle calculation. Payload figures include the standard mode3 charging cable (5kg).

# Dimensions.



RETURN TO START

## Panel Van - L2

Wheelbase	Wheelbase length	3,200mm
	Turning circle	12.9m
	Front track width	1,660mm
	Rear track width	1,646mm
Vehicle	Length	5,140mm
	Height (unladen)	1,932mm
	Width (inc. wing mirrors)	2,244mm
	Ground clearance	152mm
Load compartment	Length	2,831mm*
	Load volume	6.0m <sup>3</sup>
	Max. width	1,709mm
	Width between wheel arches	1,270mm
	Height	1,392mm
	Rear loading height (step height from ground to load floor)	565mm

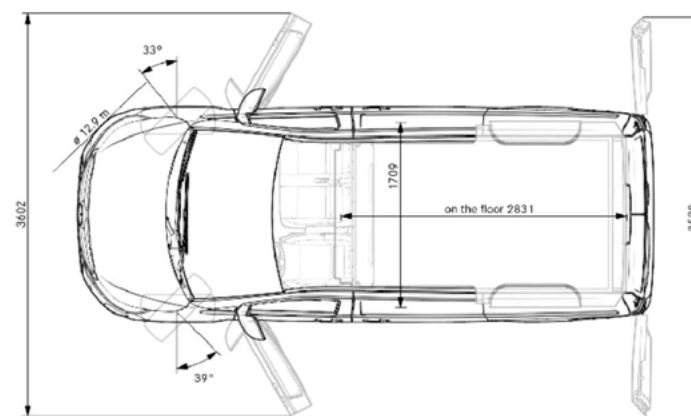
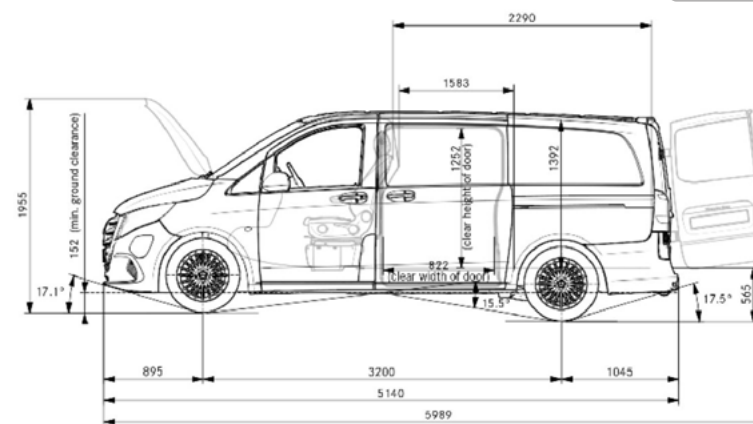
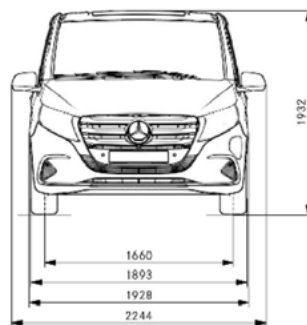

\*Measured on vehicle floor and includes 370mm for the space beneath the front seats.

# Dimensions.



RETURN TO START

## Panel Van - L3

Wheelbase	Wheelbase length	3,430mm
	Turning circle	13.7m
	Front track width	1,660mm
	Rear track width	1,646mm
Vehicle	Length	5,370mm
	Height (unladen)	1,934mm
	Width (inc. wing mirrors)	2,244mm
	Ground clearance	153mm
Load compartment	Length	3,061mm*
	Load volume	6.6m <sup>3</sup>
	Max. width	1,709mm
	Width between wheel arches	1,270mm
	Height	1,391mm
	Rear loading height (step height from ground to load floor)	570mm

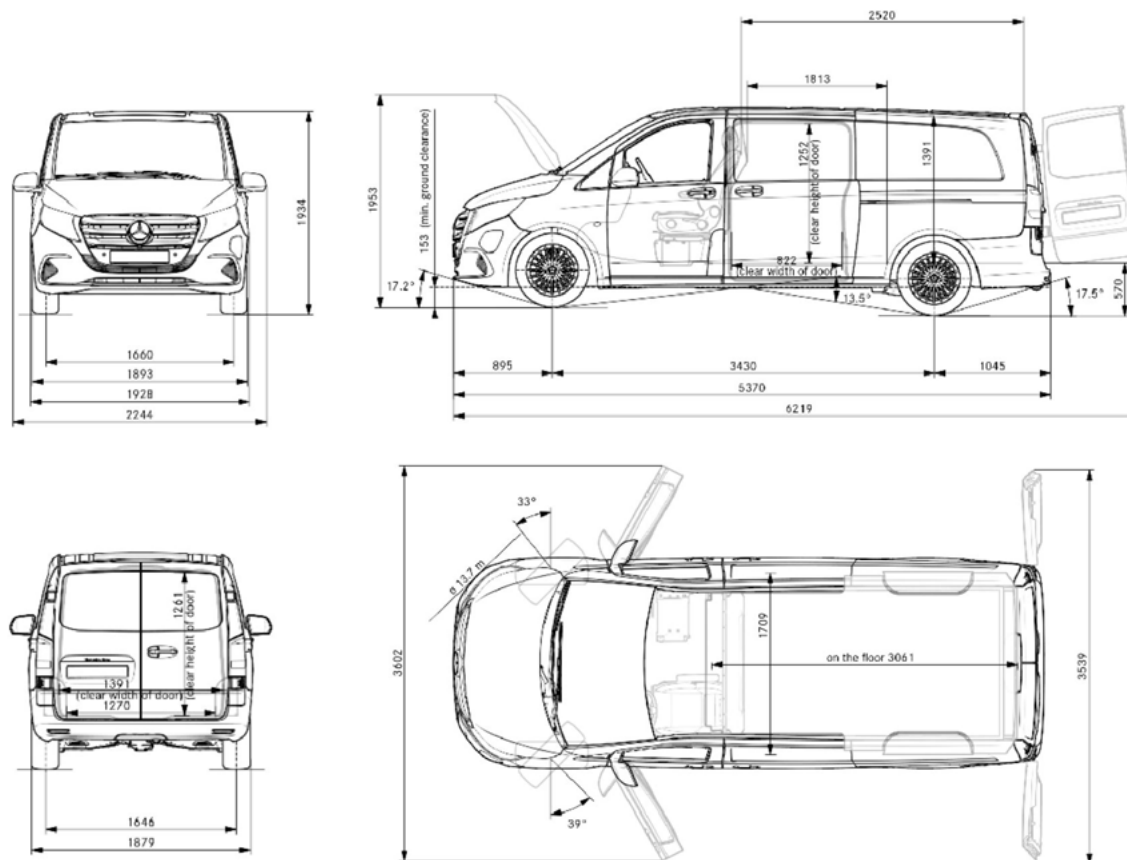

SELECT models are not available in L3 configuration.

\*Measured on vehicle floor and includes 370mm for the space beneath the front seats.

# Mercedes-Benz Electric Vans and the Environment.



RETURN TO START

A key advantage of any battery electric vehicle (BEV) is its positive environmental impact, compared to an internal combustion (ICE) vehicle. Mercedes-Benz electric vans produce no tailpipe emissions.

See right for the Energy Efficiency Rating and emission standards compliance.

### Environmental data, Mercedes-Benz electric vans

CO<sub>2</sub> is the main greenhouse gas responsible for climate change.

0	A	Rating: A 0g/km
1-50	A	
51-75	B	
76-90	C	
91-100	D	
101-110	E	
111-130	F	
131-150	H	
151-170	I	
171-190	J	
191-225	K	
226-255	L	
256+	M	

**Emission standards**

**ULEV** ✓  
Ultra Low Emission Vehicle **ULEV**

**ZEV** ✓  
Zero Tailpipe Emissions Vehicle **ZEV**

**Air quality emission zone compliance**

**ULEV** ✓  
Clean Air Zones  
(England and Wales) **CAZ**

**ULEZ** ✓  
Ultra Low Emission Zone  
(London) **ULEZ**

This vehicle(s) meets the emissions standard for private vans set by government under the Clean Air Zone (CAZ) framework for England and Wales currently in place until 2025. Stricter CAZ standards and restrictions could then apply. Some local authorities may also impose more stringent controls in certain areas. A ULEV meets the current government standard for an Ultra Low Emission Vehicle, stricter standards could apply in the future. See more about future CAZs [here](#).

## Ambition 2039

A core element of our sustainable business strategy is Ambition 2039, with which we already set the course in 2019 for a holistic approach to climate protection and air pollution control.

The ambition is to make our entire fleet of new vehicles net carbon-neutral along the entire value chain and over the vehicles' entire life cycle by 2039 – from development to the supplier network, in-house production, electrification of products to renewable energies in the use phase of electric vehicles and recycling of the vehicles to close the loop.



The Mercedes-Benz eVito

# The Mercedes-Benz App.



RETURN TO START

Monitor your van's status, location and security via your smartphone.



ASSISTANCE & AFTERCARE		FREE
<b>Telediagnosics &amp; Maintenance Management</b>	Receive a notification when wear is detected on diagnostic-capable parts such as brake pads and get advance notice of when a service is due allowing you to plan your workshop visit well in advance to minimise any impact on your business.	
<b>Remote Vehicle Diagnostics</b>	Your Dealer can assess your van's condition remotely allowing them to check if any other repairs are required ahead of a service.	
<b>Accident Recovery &amp; Breakdown Management</b>	Once an emergency call has been resolved or if you request breakdown assistance, further support is offered to help recover your van or to tow it to a Mercedes-Benz Service outlet.	
<b>Software updates</b>	Over-the-air software updates are sent directly to your van's head unit. This means you'll always know your software is up to date and you'll save time by avoiding additional workshop visits.	
VEHICLE SUPERVISION		FREE FOR 3 YEARS
<b>Vehicle Tracker</b>	See your van's location on the map in your app, making it easy to call or message your driver and re-route them to fit in another delivery or pick-up if a quicker route is available. The tracker is factory fitted equipment so it can't be easily removed if stolen.	
<b>Parked Vehicle Locator</b>	If you're within 1 mile of your van's parked location, the app can generate the most convenient walking route – very handy if you're in unfamiliar surroundings and on a busy schedule.	
REMOTE ACCESS		FREE FOR 3 YEARS
<b>Remote Retrieval of Vehicle Status</b>	Use your app to check on charge level, tyre pressure, mileage and trip information. Not only does this help you plan your day's journeys, it can save you admin time on tasks such as logging your mileage for expenses.	
<b>Remote Door Locking &amp; Unlocking</b>	The app allows you to check if your van is locked. If you lock your keys in the van or need to give another driver access, you can do it via the app, from any distance away. For added peace of mind, you'll receive an email notification when your vehicle is unlocked.	
EV SERVICES		FREE
<b>Pre-Entry Climate Control</b>	Climate control can be started remotely when your van is charging so energy used for heating will draw on the mains power to avoid depleting your battery. This means you'll have maximum comfort and battery range.	
<b>Display of Charging Stations &amp; Range on map</b>	The Mercedes-Benz App shows you charging stations in the surrounding area and enables you to set the preferred one as your destination. The range display in your app helps you plan a journey with confidence as it shows if you can reach your destination using your existing battery range.	

# Mercedes-Benz Approved Used Electric vans. Get used to more...

**More choice. More confidence. More quality – and more added extras.**

As a Mercedes-Benz Approved Used Electric customer, you'll have complete peace of mind as every van offers the same commitment to quality and workmanship as new and comes with:



12-24 month warranty option\*



Free MOT test failure cover\*\* covering you for £1,500

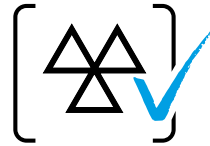

Minimum 3 months MOT



Free 24/7 breakdown cover and roadside assistance^



Comprehensive multi-point vehicle check

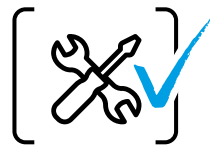

Discounted service plans

\*Warranty eligible up to 200,000 miles on approved used Mercedes-Benz Vans with less than 150,000 miles at point of sale. For full T&Cs, please speak to your preferred sales representative. \*\* MOT cover redeemable per 12-months warranty. £1,500 claims limit. For more information, please speak to your preferred sales representative. ^ Free for 12 months initially and renewed at each service, if serviced by MB according to service intervals for up to 30 years from when the vehicle was first registered. For a full list of exclusions and all product terms please visit [mbvans.co.uk/mobilovan](http://mbvans.co.uk/mobilovan) For full terms and conditions, please consult your local Dealer. Mercedes-Benz Van Insurance is a trading name of Mercedes-Benz Insurance Services UK Limited. Prices are correct at time of going to press 03/2026. All prices are subject to any fiscal or legislative changes.



Approved  
Used  
Electric



## What is an Approved Used van?

- Is no older than 6 years old
- Has less than 150,000 miles on the clock
- Is eligible for one of our flexible finance plans

➤ [Find more information and our latest Approved Used Electric offers](#)

## What is an Approved Used Electric van?

➤ [Visit our Dealer Networks Approved Used Electric van stock](#)

The Mercedes-Benz eVito

20



RETURN TO START

# All eVito models include an Integrated Service Package (ISP).

Integrated Service Package (ISP), helps to form an integral part of our commitment that the eVito is not only performing well but is safe to operate at all times.

Our ISP consists of four services: two A (minor) and two B (major) services as standard – and can be transferred to a new owner. All of our electric vehicles also come with out of charge cover and an 8 year/100,000 mile battery capacity warranty as standard.



# Service24: Demand more

## The most comprehensive Aftercare package – for businesses that demand more.

Our 120-strong Dealer network works around the clock to service and maintain your vans and keep your business moving. It all adds up to more value, more flexibility and more confidence that you'll only find at an authorised Mercedes-Benz Dealer.

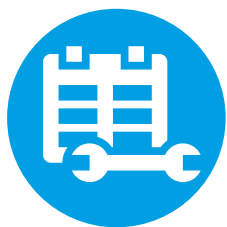

### › Flexible servicing and maintenance

Book your service online or by telephone, and as well as a standard 'drop and go' service with a courtesy van, you'll also get:

- Early bird, late night and weekend slots
- Mobile service
- Overnight service
- Collect & deliver service
- Express 1hr service
- Electric van service.

[Find out more about service and repairs](#)



### › Flexible ways to pay and save

With fixed, transparent national pricing there are no surprises with our services and repairs – plus you can fix, spread and reduce your service and maintenance costs, and ease your cashflow at the same time, with a payment plan.

- Pay as You Go
- ServiceCare Maintenance
- ServiceCare Flex (specifically for fleets)
- ServiceCare Complete.

[Find out more about service options](#)



### › 3-year unlimited mileage warranty

Available on every new van, all service and maintenance – and any work required – is covered by your 3-year unlimited mileage warranty, and is only undertaken by Mercedes-Benz trained technicians using Mercedes-Benz GenuineParts.

### › 8 year/100,000 mile battery certificate

For peace of mind and reliable performance, the eVito's battery comes with an impressive 8 year/100,000 mile battery guarantee.

[Find out more about warranties](#)

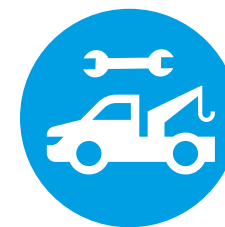

### › Free breakdown cover & roadside assistance\*

Every van comes with free Europe-wide breakdown cover – MobiloVan. And with 3 years' cover on new vehicles for driver mishaps, no one goes further to keep your business moving.

- Trained technicians using only Mercedes-Benz GenuineParts
- Out of charge cover for electric vehicles
- Forward travel of load and crew is covered
- Driver mishap cover for the first 3 years, including out of charge cover or empty fuel tanks.

[Find out more about MobiloVan](#)

\*For a full list of exclusions and all product terms please visit [www.mercedes-benz.co.uk/vans/en/Owners/MobiloVan](http://www.mercedes-benz.co.uk/vans/en/Owners/MobiloVan)

The Mercedes-Benz eVito

22

May 2026

Mercedes-Benz UK Limited, Delaware Drive, Tongwell, Milton Keynes, MK15 8BA. Company number: 02448457

[www.mercedes-benz.co.uk](http://www.mercedes-benz.co.uk)