

Mercedes-Benz

eVITO.

Tourer.

Prices effective from May 2026





RETURN TO START



## Contents

› <b>Model overview</b>	<b>3</b>
› <b>Standard equipment highlights</b>	
The eVito Tourer PRO	<b>5</b>
The eVito Tourer SELECT	<b>6</b>
› <b>List prices</b>	<b>7</b>
› <b>Mercedes-Benz Finance Options</b>	<b>8</b>
› <b>Equipment</b>	<b>9</b>
› <b>Colours and Upholstery</b>	<b>15</b>
› <b>Charging options</b>	<b>16</b>
› <b>Battery and eMotor</b>	<b>17</b>
› <b>Range and energy consumption</b>	<b>18</b>
› <b>Weights and payloads</b>	<b>19</b>
› <b>Dimensions</b>	<b>20</b>
› <b>Mercedes-Benz Vans and the environment</b>	<b>22</b>
› <b>The Mercedes-Benz App</b>	<b>23</b>
› <b>Approved Used</b>	<b>24</b>
› <b>Integrated Service Package (ISP)</b>	<b>25</b>
› <b>Service24: Demand more</b>	<b>26</b>

### Please note

This document provides information about the model range line-up and specifications of the eVito Tourer. It also contains key details about options, economy and performance of all variants. Details are correct at time of publication and are subject to revision. Any images used in this document may not reflect UK specification and are for illustrative purposes only. Images may show optional equipment which does not form part of UK standard specification.



RETURN TO START

# The Mercedes-Benz eVito Tourer.

1 model:	Tourer with 8 or 9 seats
2 vehicle lengths:	L2: 5,140mm L3: 5,370mm
2 trims:	PRO SELECT
2 charging powers:	AC 11kW (Standard) DC 110kW (Standard)

Combined WLTP ranges:  
225 - 228 miles\*

Charging times:\*

- AC 11kW 0-100% in 10 hours
- DC 110 kW 10-80% in 40 minutes



eVito Tourer PRO



eVito Tourer SELECT

Discover the eVito Panel Van models in our range:

▶ [The eVito Panel Van range](#)

Discover more about the other Mercedes-Benz electric models:

▶ [The electric vehicles range](#)

Electrical WLTP range for the eVito Tourer 90kWh range in miles (km): 225 (362) – 228 (367). Electrical consumption in kWh/100km: 27.0 – 27.4. Combined CO<sub>2</sub> emissions in g/km: 0.

Figures correct as of April 2025. The indicated values were determined according to the prescribed measurement method – Worldwide Harmonised Light Vehicle Test Procedure (WLTP). Battery Electric Vehicles (BEV) require mains electricity for charging, range figures determined with the battery fully charged. Figures shown are for comparability purposes; only compare with other cars tested to the same technical procedure (WLTP). Figures may not reflect real life driving results, which will depend upon a number of factors including the starting charge of the battery, factory-fitted options, accessories fitted (post registration), variations in weather, driving styles and vehicle load. Further information about the test used to establish range, power consumption and CO<sub>2</sub> figures can be found at <http://www.mercedes-benz.co.uk/WLTP>. For real time data visit [https://voc.mercedes-benz.com/voc/gb\\_en](https://voc.mercedes-benz.com/voc/gb_en). \*\*Charging times are subject to the power available at the location where the vehicle will be charged as well as external factors such as temperature and type of cable and charger used.

# Enhanced Safety.



RETURN TO START

The eVito is based on a sophisticated safety concept. Active driving assistance and safety systems offer useful functions to support the driver. A significantly expanded standard range of assistance systems is available.

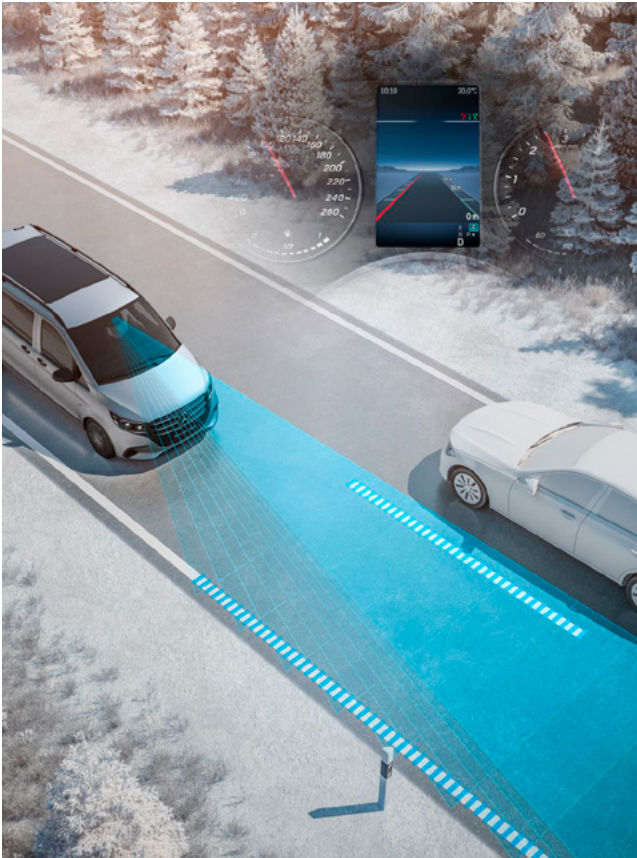

## Active Lane Keeping Assist (JB4)

Protects against unintentional lane departure. If the system's camera detects a lane departure, a corrective steering intervention takes place to guide the vehicle back into the lane. If the driver fails to react and the vehicle crosses the lane markings, an additional haptic warning occurs (pulsed vibration via the steering wheel).

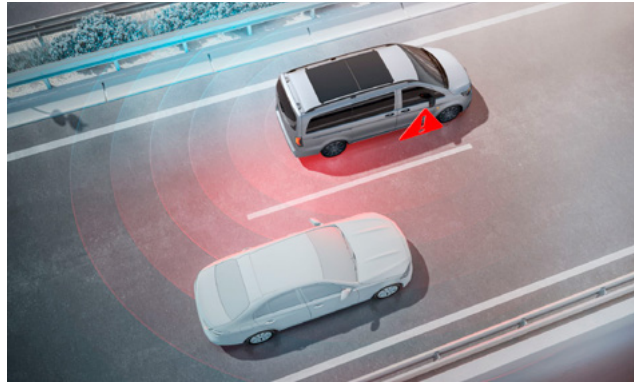

## Blind Spot Assist (JA7)

Helps when changing lanes and reversing. If a vehicle is detected, a warning sign in a red triangle appears in the corresponding exterior mirror.



## Intelligent Speed Assist (JS2)

Displays the current speed limit in the driver's direct field of vision in the instrument cluster.



## ATTENTION ASSIST (JW8)

Can help to avoid momentary nodding off and therefore provides you with increased safety, in particular when driving at night and on long journeys. The system provides you with a visual and audible warning if it identifies typical signs of fatigue or attention lapses, and suggests taking a break.

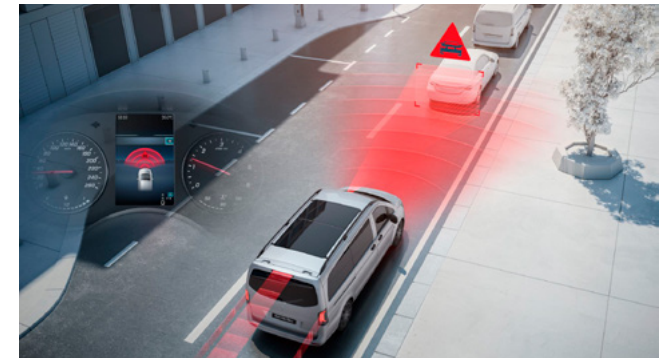

## Active Brake Assist (BA3)

With pedestrian and cyclist detection. The system helps to prevent rear-end collisions. Active Brake Assist can help you to prevent accidents (with vehicles driving in front, with crossing pedestrians or cyclists) or to minimise their consequences.

# The eVito Tourer PRO.

Standard features include:

## Interior

- TEMPMATIC air conditioning
- Double co-driver's seat on L2 (Single seat on L3)
- 3-seat bench first row with folding outer seat
- 3 seater bench second row
- Adjustable steering wheel, reach and rake
- Multifunction steering wheel
- Leather steering wheel
- Locking glovebox
- Modern instrument cluster with 5.5" TFT colour display
- Heated driver seat

## Exterior

- 17" Alloy wheels (20 spoke design)
- Summer tyres
- Exterior mirror heated and electr. adjustable
- Window in tailgate with wipe/wash system

## Rear Passenger Area

- Plastic flooring, TPO, in passenger compartment
- Interior panelling higher execution
- Twin sliding doors
- Grab handles in rear
- Weld nuts in sidewall for conversions

## Safety and Driver Assistance Systems

- Driver and Co-driver airbag
- Active Brake Assist
- ATTENTION ASSIST
- Headlight assistant
- Reversing camera
- Blind spot assist
- Cruise control
- Alarm and double locks
- Emergency call system
- Driver camera

## Technology

- MBUX multimedia system with 10.25" Touchscreen
- Digital Extra: Smartphone Integration
- 2-way loudspeakers in front and rear
- Pre-entry climate control



Basic recommended list price (ex.VAT) for the eVito Tourer L2 PRO

£64,345

➤ [Arrange a test drive at your nearest Dealership](#)

\* Vehicle purchase price is calculated on base vehicle only (excluding any optional equipment), it excludes delivery charges and first registration fee. The grant will be applied after any vehicle discount has been offered and includes VAT and number plate costs. For more information, visit: <https://www.gov.uk/plug-in-car-van-grants>

# The eVito Tourer SELECT.

Upgrade from PRO to SELECT to get all of the additional equipment listed below:

## Interior

- Chrome interior appointments package
- Comfort driver's seat
- Comfort co-driver's seat on L3
- 3-seat face-to-face comfort benches on L3
- Lumbar support for driver's seat
- Automatically dimming interior mirror

## Exterior

- 17" Alloy wheels (5 twin-spoke design)
- Chromed radiator grille
- Metallic paint
- Colour-coded front and rear bumpers
- Mirror package



RETURN TO START



Basic recommended list price (ex.VAT) for the eVito Tourer L2 SELECT

£70,085

➤ [Arrange a test drive at your nearest Dealership](#)

\* Vehicle purchase price is calculated on base vehicle only (excluding any optional equipment), it excludes delivery charges and first registration fee. The grant will be applied after any vehicle discount has been offered and includes VAT and number plate costs. For more information, visit: <https://www.gov.uk/plug-in-car-van-grants>



The Mercedes-Benz eVito Tourer

eVito Tourer overview	eVito Tourer PRO	eVito Tourer SELECT	List prices	Equipment	Battery and eMotor	Range and energy consumption	Weights and payloads	Dimensions	Mercedes-Benz App	Approved Used	ISP	Service24
-----------------------	------------------	---------------------	-------------	-----------	--------------------	------------------------------	----------------------	------------	-------------------	---------------	-----	-----------

# List Price Summary.



RETURN TO START

Vehicle Model Description	Powertrain	CO <sub>2</sub> emissions, WLTP	Basic Recommended Retail Price (Ex. VAT)	Total Recommended Retail Price (Inc. VAT)
eVito Tourer L2 PRO	Battery electric vehicle, 204PS/150kW, FWD, single-speed automatic transmission Electric range 228 miles WLTP combined	0g/km	£64,345	£77,214
eVito Tourer L2 SELECT	Battery electric vehicle, 204PS/150kW, FWD, single-speed automatic transmission Electric range 227 miles WLTP combined	0g/km	£70,085	£84,102
eVito Tourer L3 PRO	Battery electric vehicle, 204PS/150kW, FWD, single-speed automatic transmission Electric range 227 miles WLTP combined	0g/km	£65,130	£78,156
eVito Tourer L3 SELECT	Battery electric vehicle, 204PS/150kW, FWD, single-speed automatic transmission Electric range 224 miles WLTP combined	0g/km	£70,870	£85,044

## Carbon Neutral Production

All Mercedes-Benz Vans and Cars, including the eVito, will benefit from carbon-neutral production starting from January 2022.

This document is for guidance only and must be used in conjunction with a configuration tool prior to final specification decisions and vehicle quotations being prepared and accepted. List prices are quoted ex-factory unless otherwise stated. Delivery charges excluding VAT will be added to model prices quoted in this document. Prices based on standard finish paint choice. Mercedes-Benz Vans UK and authorised Dealers reserve the right to alter specification and vary prices without notice. The availability of options may depend on the chosen base vehicle and other optional equipment specified, and should be confirmed with your Mercedes-Benz Vans Dealer prior to order placement. VAT is calculated at the standard rate of 20%. Mercedes-Benz Vans UK Ltd, Tongwell, Milton Keynes MK15 8BA.



RETURN TO START

# Mercedes-Benz Finance options.

## Choose an agreement that suits you with Mercedes-Benz Finance.

At Mercedes-Benz Finance we understand what it takes to run a modern-day business. Because of this, we have a number of finance options ready to suit your business needs.

### Agility (Personal Contract Plan)

Agility (Personal Contract Plan) is our most flexible method of financing. You drive the vehicle over a fixed term, with fixed monthly payments. And at the end of the agreement, you decide whether you want to:

- Buy another Mercedes-Benz.
- Purchase your van by paying the Optional Purchase payment (balloon) and Option to Purchase Fee.
- Return it to us.

As a business customer, your vehicle can also appear as an asset on your balance sheet.

[For more information about Agility.](#)

### Hire Purchase

A straightforward route to ownership. This product allows you to spread the overall cost of your Mercedes-Benz over a fixed term.

As a business customer, your vehicle can also appear as an asset on your balance sheet.

[For more information on Hire Purchase.](#)

### Operating Lease

A solution for those who want to drive one of our vehicles over a specific term, with fixed monthly rentals and without the commitment of ownership of the vehicle.

As a business customer, your vehicle can also appear as an asset on your balance sheet.

[For more information on Operating Lease.](#)

### Contract Hire

A solution for those who want to drive one of our vans over a specific term, with fixed monthly rentals and without the need to commit to ownership of the vehicle. This includes the cost of your Vehicle Excise Duty (also known as Road Fund Licence) for the duration of your agreement.

As a business customer, your vehicle can also appear as an asset on your balance sheet.

[For more information on Contract Hire.](#)

### Finance Lease

Finance Lease gives you the ability to enjoy driving a Mercedes-Benz Van for a fixed time without the option of ownership. With this option you lease your vehicle for a fixed period and for fixed monthly rentals.

As a limited company or PLC customer, your vehicle can also appear as an asset on your balance sheet.

[For more information on Finance Lease.](#)

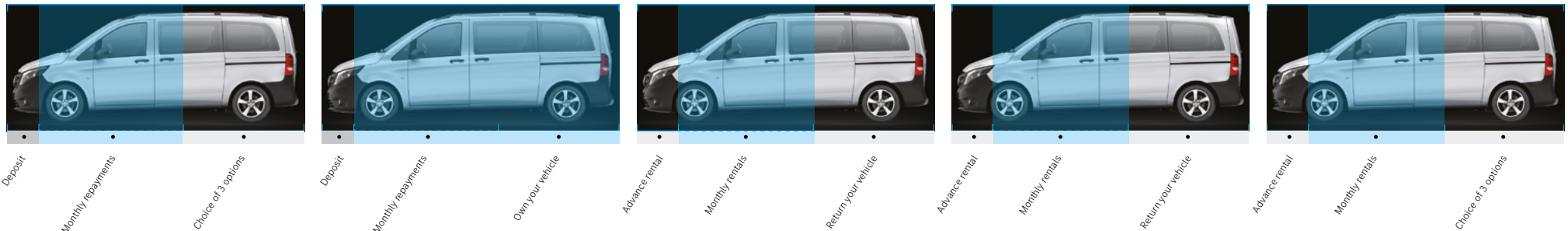

[For more information about our finance options](#)

# Equipment.



RETURN TO START

Key: ● Standard ○ Optional ◇ Equipment dependant option available — Not available

Equipment	Description	Option code	PRO	SELECT	Basic Price exc. VAT	Basic Price inc. VAT
<b>Upgrade packages</b>						
<b>Mirrors</b>	<b>Mirror package</b> The Vito Mirror package uses automatically dimming mirrors and electrically folding outside mirrors to increase the driving comfort and driving safety.	FP2	—	●	—	—
<b>Trim and Upholstery</b>	<b>Chrome interior appointments package</b> The chrome interior package further enhances the look of the driver's and front-passenger's area with its trim elements on the dashboard and in the front doors.	FP4	○	●	£175.00	£210.00
<b>Maintenance</b>	<b>Maintenance package</b> This package includes regular maintenance work and the inspection of important high-voltage components, other vehicle parts and functions during the first 4 years.	JE1	●	●	—	—
<b>Driver Assistance</b>	<b>Driver Assistance Package</b> Includes new features: route based speed adjustment (JM3), extended automatic start-up on motorways (JM2) and Active speed limit assist (JM4).	JS3	○	○	£1,210.00	£1,452.00

Changes to individual option availability and combinations may occur depending on vehicle specification choices and the continuing evolution and adaptation of our product range. These changes may not be immediately reflected in this document as they occur, but will be introduced at the next revision opportunity.

# Equipment.



RETURN TO START

Equipment	Description	Option code	PRO	SELECT	Basic Price exc. VAT	Basic Price inc. VAT
<b>Exterior Features</b>						
<b>Bodywork</b>	<b>Chromed radiator grille</b> Only available in conjunction with painted bumpers (CM2).	FK2	○	●	£175.00	£210.00
	<b>Roof rails</b> Maximum load of 150kg, when supported by three carrier bars.	D12	○	○	£505.00	£606.00
<b>Doors</b>	<b>Electrically operated side loading doors (right)</b> Not available in conjunction with W19.	T55	○	○	£1,010.00	£1,212.00
	<b>Electrically operated side loading doors (left)</b> Not available in conjunction with W18.	T56	○	○	£1,010.00	£1,212.00
	<b>Tailgate</b>	W65	●	●	—	—
<b>Paint</b>	<b>Pre-treated bumpers</b> The pre-treated surfaces facilitate the painting of the bumpers in the desired colour at a later date.	CM3	○	—	£170.00	£204.00
	<b>Colour-coded front and rear bumpers</b>	CM2	○	●	£440.00	£528.00
	<b>Metallic or non-metallic optional paint colour</b> See page 15 for the range of colours available, or speak to your local Mercedes-Benz Van Dealer.	n/a	○	○	Varies by colour	Varies by colour
<b>Roof</b>	<b>Panoramic glass sunroof</b> available on L2 only	D34	○	○	£3,535.00	£4,242.00
<b>Tyres</b>	<b>Comfort tyres</b>	RM4	●	●	—	—
<b>Wheels</b>	<b>17" steel wheels</b> Wheel: 6.5 J x 17 ET 51 Tyres: 225/55 R17	R17	○	○	£840.00	£1,008.00
	<b>17" Alloy wheels (20 spoke) painted in vanadium silver</b> Wheel: 7 J x 17 ET 51 Tyres: 225/55 R17	RK8	●	○	£0.00	£0.00
	<b>17" Alloy wheels (5 twin-spoke)</b> Wheel: 7 J x 17 ET 51 Tyres: 225/55 R17 or 235/55 R17	R1N	○	●	£985.00	£1,182.00
<b>Interior Features</b>						
<b>Flooring</b>	<b>Front carpets</b>	V44	○	○	£65.00	£78.00
	<b>Rear carpets</b>	V33	○	○	£115.00	£138.00
	<b>Velour floor mats</b> The black velour floor mats visually enhance the cockpit and underscore the elegant, sporty, wellness ambience in the vehicle.	VL2	○	○	£65.00	£78.00
<b>Heating and Ventilation</b>	<b>Electrical auxiliary demister heating elements</b> The electric heater booster ensures a stronger and faster heating output for the vehicle interior in low outside temperatures when the engine is cold.	HZ0	●	●	—	—
	<b>TEMPMATIC air-conditioning</b> Semi-automatic temperature control including outside air temperature display.	HH9	●	●	—	—
	<b>Rear TEMPMATIC air-conditioning</b>	HZ7	○	○	£985.00	£1,182.00
	<b>THERMOTRONIC climate control</b> Dual zone automatic climate control.	HH4	○	○	£810.00	£972.00

● Standard ○ Optional ◇ Equipment dependant option available — Not available

# Equipment.



RETURN TO START

Equipment	Description	Option code	PRO	SELECT	Basic Price exc. VAT	Basic Price inc. VAT
<b>Interior Features (cont.)</b>						
<b>Seating</b>	<b>Comfort driver's seat</b> Comfort driver seat with inboard armrest and 4-way adjustable headrest.	SB1	○	●	£210.00	£252.00
	<b>Comfort co-driver's seat</b> standard on L3 SELECT Comfort driver and co-driver seat with inboard armrests and 4-way adjustable headrests.	SB2	○	○	£210.00	£252.00
	<b>Comfort bench seat second passenger row as luxury bunk</b>	US3	○	○	£575.00	£690.00
	<b>3-seater comfort bench 1st row with folding outer seat</b> standard on L3 SELECT	US4	○	○	£605.00	£726.00
	<b>3-seater comfort bench 2nd row with folding outer seat</b> standard on L3 SELECT	US5	○	○	£780.00	£936.00
	<b>Seat anch., face-to-face, 1st rear seat row, rails</b> standard on L3 SELECT	U3V	○	○	–	–
	<b>Single co-driver's seat</b> standard on L3 PRO Includes automatic seat belt recognition and airbag deactivation function.	S09	○	○	£0.00	£0.00
	<b>Double co-driver's seat</b> standard on L2s. Not available on L3s.	S23	●	●	–	–
	<b>Driver's seat electrically adjustable</b>	SF1	–	○	£1,275.00	£1,530.00
	<b>Co-driver's seat electrically adjustable</b>	SF2	–	○	£1,275.00	£1,530.00
	<b>Heated driver's seat</b>	H16	●	●	–	–
	<b>Heated co-driver's seat</b>	H15	○	○	£265.00	£318.00
	<b>Lumbar support, driver's seat</b> Only available in conjunction with comfort seat (SB1), electronically adjustable (SF1). Not available with leatherette trim (VU9).	SE5	○	●	£75.00	£90.00
	<b>Lumbar support, co-driver's seat</b> Only available in conjunction with comfort seat (SB2), electronically adjustable (SF2). Not available with leatherette trim (VU9).	SE4	○	○	£75.00	£90.00
<b>Steering Wheel</b>	<b>Multifunctional steering wheel</b> Height and rake adjustable (CL1).	C6L	●	●	–	–
	<b>Leather steering wheel</b>	CL3	●	●	–	–
	<b>Steering wheel heating</b>	CK8	○	○	£280.00	£336.00

● Standard ○ Optional ◇ Equipment dependant option available — Not available

# Equipment.



RETURN TO START

Equipment	Description	Option code	PRO	SELECT	Basic Price exc. VAT	Basic Price inc. VAT
<b>Interior Features (cont.)</b>						
<b>Storage</b>	<b>2 detachable cup holders, in rear armrests</b>	FG9	○	○	£65.00	£78.00
	<b>Armrests for crew/passenger compartment</b> Fitted to the outer side of the crew/passenger compartment bench seat.	U73	○	○	£120.00	£144.00
	<b>Footwell centre console with stowage compartment</b> Not available in conjunction with dual co-driver seat (S23).	FF1	—	○	£125.00	£150.00
	<b>Parcel shelf</b> The load compartment shelf creates a second stowage space that makes the load compartment flexible and enables convenient loading and unloading.	YG4	○	○	£745.00	£894.00
	<b>Stowage net on driver's seat backrest</b>	SZ7	○	○	£40.00	£48.00
	<b>Stowage net on co-driver's seat backrest</b>	SZ8	○	○	£40.00	£48.00
<b>Trim and upholstery</b>	<b>Black Caluma seat upholstery</b> Breathable and hardwearing.	VF4	●	●	—	—
	<b>Black leatherette seat upholstery</b>	VU9	○	○	£245.00	£294.00
<b>Lighting</b>	<b>Lighting for footwell, front</b>	LC7	○	○	£0.00	£0.00
<b>Technology, Software and Electrics</b>						
<b>Audio</b>	<b>MBUX Multimedia System</b>	E7M	●	●	—	—
	<b>2-way loudspeakers, front and rear</b>	EL9	●	●	—	—
	<b>Digital Extra: Smartphone Integration</b> Required for Android Auto and Apple CarPlay. (Requires pairing of the vehicle with a Mercedes-Benz ID).	E4S	●	●	—	—
	<b>Digital Extra: Hard-disc navigation</b>	E1E	○	○	£900.00	£1,080.00
	<b>Wireless charging system for mobile devices</b>	E10	○	○	£105.00	£126.00
<b>Battery</b>	<b>Heavy duty battery</b>	ED4	●	●	—	—
<b>Charging</b>	<b>Charging cable, mode 3 (type 2 3x32A) 8m</b>	E9L	●	●	—	—
	<b>Charging cable, mode 3 (type 2, 3x32A, 22kW) 5m</b>	E2K	○	○	£145.00	£174.00
<b>Electrical</b>	<b>Parameterisable special module (PSM)</b> Facilitates programming of special vehicle functions. Please speak to your Mercedes-Benz Vans Dealer for more information.	ED5	○	○	£520.00	£624.00
	<b>12V Plug socket in trunk/load compartment</b>	ES2	○	○	£70.00	£84.00
<b>Keys</b>	<b>Additional vehicle keys with remote function</b> Four keys are supplied with the vehicle in total.	FZ9	○	○	£175.00	£210.00

● Standard ○ Optional ◇ Equipment dependant option available — Not available

# Equipment.



RETURN TO START

Equipment	Description	Option code	PRO	SELECT	Basic Price exc. VAT	Basic Price inc. VAT
<b>Driver's Assistance and Safety</b>						
<b>Airbags</b>	<b>Driver's thorax airbag</b>	SH1	●	●	–	–
	<b>Co-driver's thorax airbag</b>	SH2	●	●	–	–
	<b>Window airbags</b> Fitted for driver and co-driver, from A-pillar to B-pillar.	SH9	●	●	–	–
	<b>Window airbags, A-D-pillar</b> Available on L2 only.	SH8	○	○	£1,165.00	£1,398.00
<b>Driver's Assistance</b>	<b>Active Brake Assist</b> Can detect the danger of a collision with the vehicle ahead, stationary traffic and pedestrians by reacting with a visual and audible warning-braking automatically if there is no driver reaction.	BA3	●	●	–	–
	<b>Airmatic</b> Air suspension allowing comfortable driving and enhanced off-road capabilities	CA4	○	○	£2,370.00	£2,844.00
	<b>Active Distance assist DISTRONIC</b> Automatically maintains the distance to vehicles in front. The system accelerates the vehicle by itself and brakes it with a maximum of half the vehicle's braking power in order to maintain a safe distance.	ET4	○	○	£1,140.00	£1,368.00
	<b>Hill-Start Assist</b>	E07	●	●	–	–
	<b>ATTENTION ASSIST</b> ATTENTION ASSIST function can detect typical signs of drowsiness and warn the driver.	JW8	●	●	–	–
	<b>Blind Spot Assist</b> Blind Spot assist can help prevent accidents when changing lanes, for example on the motorway.	JA7	●	●	–	–
	<b>Intelligent Speed Assistant</b>	JS2	●	●	–	–
	<b>Comfort overhead control panel</b> LED interior lighting including cab downlighting and co-/driver reading lamps; also includes a convenient spectacles compartment.	LC4	●	●	–	–
	<b>Cruise control</b>	MS1	●	●	–	–
	<b>Headlight assistant</b> Automatically switches the vehicle lighting between daytime-running lights and low beam headlights.	LA2	●	●	–	–
	<b>Active Lane Keeping assist</b> Warns the driver if lane markings are crossed unintentionally.	JB4	●	●	–	–
	<b>Driver camera</b>	JK8	●	●	–	–
	<b>Linear speed limiter 140km/h</b>	MJ3	●	●	–	–
	<b>Traffic Sign Assist</b>	JA9	○	○	£0.00	£0.00
<b>Child detection in vehicle, passive</b>	SK6	●	●	–	–	
<b>Parking</b>	<b>Reversing camera</b>	FR8	●	●	–	–
	<b>Parking package with 360° camera</b>	JB6	–	○	£1,880.00	£2,256.00
	<b>Parking package with reversing camera</b>	JB7	○	○	£1,300.00	£1,560.00

● Standard ○ Optional ◇ Equipment dependant option available – Not available

# Equipment.



RETURN TO START

Equipment	Description	Option code	PRO	SELECT	Basic Price exc. VAT	Basic Price inc. VAT
<b>Driver's Assistance and Safety (cont.)</b>						
<b>Safety Equipment</b>	<b>First aid kit</b>	Y10	○	○	£65.00	£78.00
	<b>Warning triangle</b>	Y44	○	○	£50.00	£60.00
	<b>PRE-SAFE</b> The PRE-SAFE® anticipatory occupant protection system can detect critical driving situations at an early stage and initiate preventive protection measures.	JP1	○	○	£455.00	£546.00
<b>Lighting</b>	<b>Blinker lights on rear of roof</b> The additional turn signal lamps on rear of roof improve the visibility of the vehicle, thus enhancing perceptual safety.	L84	○	○	£195.00	£234.00
	<b>Illuminated vanity mirror in sun visors</b>	FS5	●	●	–	–
	<b>Interior and ambient lighting</b>	LP2	○	○	£315.00	£378.00
	<b>MULTIBEAM LED with Highbeam Assist PLUS</b>	L45	○	○	£2,330.00	£2,796.00
	<b>LED tail lamps, brake lamps and indicators</b>	LG4	○	○	£0.00	£0.00
	<b>Lights in grab handle in rear</b>	LC3	○	○	£75.00	£90.00
<b>Loading and Towing</b>						
<b>Gross Vehicle Weight (GVW)</b>	<b>Gross Vehicle Weight 3.5T</b>	X16	●	●	–	–
<b>Mirrors and Windows</b>						
<b>Mirrors</b>	<b>Electrically folding door mirrors</b> Only available in conjunction with Electrically heated and adjustable door mirrors (F68).	F64	–	●	–	–
	<b>Heated, electrically adjustable wing mirrors</b> Mirror heating reduces condensation in cold weather and prevents icing-up of the mirrors. The exterior mirrors are heated automatically upon vehicle start when the outside temperature is low or when the rear defrost function is activated.	F68	●	●	–	–
<b>Windows</b>	<b>Black-tinted windows in rear</b> 90% window tint offers attractive thermal and privacy protection. Applies to all windows after the B-pillar.	W70	○	○	£525.00	£630.00
	<b>Convenience closing</b> Convenience closing of the front windows via remote central locking.	F3Z	●	●	–	–
	<b>C-D pillar windows</b> Includes tinted glass–lightly tinted, green (H20).	W29	●	●	–	–
	<b>Heat-insulating glass</b> Windscreen (laminated glass), side windows and rear window (single-pane safety glass) are tinted green, reducing the sunlight's heating effect on the interior.	H20	●	●	–	–

● Standard ○ Optional ◇ Equipment dependant option available – Not available

# Colours and upholstery.



RETURN TO START

## Solid paints



Arctic White  
(Standard for PRO)



Jupiter Red



Steel Blue

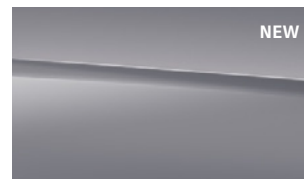

Alpine Grey



Vintage Blue

## Metallic paints

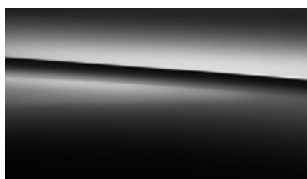

Obsidian Black



Hightech Silver

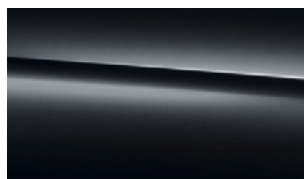

Graphite Grey

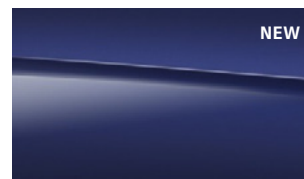

Sodalite Blue



Kalahari Gold



Hyacinth Red

## Interior upholstery

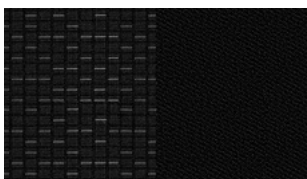

Black Caluma seat upholstery  
(Standard)

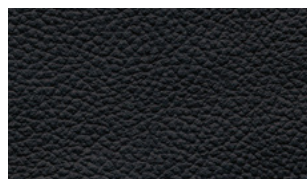

Black leatherette seat upholstery  
(Optional)

# Charging options – maximise range and reduce downtime.

## › The eVito Tourer can be charged via Direct Current (DC) and Alternating Current (AC).

The DC option offers speed, while AC is more cost effective for overnight charging. DC is available at most UK service stations and will charge your vehicle faster but requires more energy to do so.

- DC 110kW – 10-80% rapid charge in 40 minutes†

AC requires longer intervals to fully charge but uses less energy:

- AC 11kW: 0-100% in 10 hours†

## › Optimising battery performance.

When you're busy, every mile counts. That's why the eVito Tourer recovers energy when it is decelerating, optimise the vehicle's range. This is called recuperation and you can select five different modes via the gearshift paddles. The greater the recuperation, the faster you decelerate when you let off the accelerator and the more energy the vehicle regenerates.

**D--** This mode is designed to get maximum range from your eVito Tourer. With the fastest deceleration, it recovers the most energy. As the deceleration is so strong, your brake lights will be automatically activated.

**D-** When you ease off the accelerator in D-, your vehicle will slow down less quickly and recover a little less energy than D--. Generally, this mode will activate your brake lights.

**D** This mode is good for faster paced traffic traveling at a relatively constant speed and the vehicle returns to D every time you start the motor. It has a gradual deceleration feel – like putting a diesel vehicle into a lower gear. Some energy is recovered, but not as much as D-. Brake lights are generally not automatically activated in this mode.

**D+** This is a sailing mode, meaning your vehicle will decelerate naturally – like coasting to a stop in a diesel vehicle. No energy is recovered into the battery. It is useful on long downhill sections of main roads, as you will be able to 'sail' with no drag from the electric motor.

**D Auto** With a long pull of either paddle shifter, the intelligent mode D Auto is activated. It uses a radar sensor and navigation data to automatically adjust the recuperation level to the traffic situation – so you don't have to.

† Charging times are subject to the power available at the location where the vehicle will be charged as well as factors such as temperature and type of cable used. Time stated is based on 7.4/80 KW power available.

\* Subject to eligibility. Terms and conditions apply. Please speak to your preferred eReady Dealer for more information.



RETURN TO START



The Mercedes-Benz eVito Tourer 16

# Battery and eMotor.



RETURN TO START

	eVito Tourer PRO	eVito Tourer SELECT
Fuel	Electricity	
eMotor output, max.	150kW (Temporary) 70kW (Long run)	
	204PS	
Torque, max.	365Nm	
Driven Axle	Front	
Battery Composition	Lithium Ion	
Battery Capacity	100kWh (90kWh useable)	
Battery Voltage	400	
Battery Charging Power	AC: 11kW / DC: 110 kW	
Battery Charging Time	AC 0-100% - 10 hours / DC 10-80% - 40 min**	
Charging cable	8m long - Type 2, 3x32A	

\*Electrical WLTP range for the eVito Tourer 90kWh range in miles (km): 225 (362) - 228 (367). Electrical consumption in kWh/100km: 27.0 - 27.4. Combined CO<sub>2</sub> emissions in g/km: 0.

Figures correct as of April 2025. The indicated values were determined according to the prescribed measurement method - Worldwide Harmonised Light Vehicle Test Procedure (WLTP). Battery Electric Vehicles (BEV) require mains electricity for charging, range figures determined with the battery fully charged. Figures shown are for comparability purposes; only compare with other cars tested to the same technical procedure (WLTP). Figures may not reflect real life driving results, which will depend upon a number of factors including the starting charge of the battery, factory-fitted options, accessories fitted (post registration), variations in weather, driving styles and vehicle load. Further information about the test used to establish range, power consumption and CO<sub>2</sub> figures can be found at <http://www.mercedes-benz.co.uk/WLTP>. For real time data visit [https://voc.mercedes-benz.com/voc/gb\\_en](https://voc.mercedes-benz.com/voc/gb_en). \*\*Charging times are subject to the power available at the location where the vehicle will be charged as well as external factors such as temperature and type of cable and charger used.

# Range and Energy Consumption.



RETURN TO START

Model	Range, WLTP (km/miles)	
	Combined	Low to Medium
eVito Tourer L2 PRO	367/228	440/273
eVito Tourer L2 SELECT	366/227	439/273
eVito Tourer L3 PRO	366/227	439/273
eVito Tourer L3 SELECT	362/225	430/267

Model	Energy Consumption (WLTP) kWh/100km				
	Combined	Low (Extra Urban)	Medium (Urban)	High (Rural)	Extra High (Motorway)
eVito Tourer L2 PRO	27.0	22.2	22.6	24.0	34.1
eVito Tourer L2 SELECT	27.1	22.3	22.6	24.0	34.1
eVito Tourer L3 PRO	27.1	22.3	22.6	24.0	34.1
eVito Tourer L3 SELECT	27.4	22.7	23.1	24.3	34.4

The indicated values were determined according to the prescribed measurement method - Worldwide Harmonised Light Vehicle Test Procedure (WLTP). Figures shown may include options which are not available in the UK. For Battery Electric Vehicles (BEV) figures determined with battery fully charged. The Mercedes-Benz eVito Tourer requires mains electricity for charging. Figures shown are for comparability purposes; only compare consumption, CO<sub>2</sub> and electric range figures with other vehicles tested to the same technical procedures. Figures may not reflect real life driving results, which will depend upon a number of factors including the starting charge of the battery, factory-fitted options, accessories fitted (post registration), variations in weather, driving styles and vehicle load. Zero emissions while driving. Further information about the test used to establish figures can be found at <http://www.mercedes-benz.co.uk/WLTP>

# Weights and payloads.



RETURN TO START

Model	Gross Vehicle Weight (kg)	Payload (kg)	Kerb weight, with driver (kg)*
eVito Tourer L2 PRO	3,500	722	2,778
eVito Tourer L2 SELECT	3,500	714	2,786
eVito Tourer L3 PRO	3,500	718	2,782
eVito Tourer L3 SELECT	3,500	650	2,850

\* Kerb weight includes 75kg driver

All figures are based on a standard specification. The choice of wheels and transmission may affect CO<sub>2</sub> emissions and corresponding Road Fund Licence. The indicated values were determined according to the prescribed measurement method – Worldwide Harmonised Light Vehicle Test Procedure (WLTP). Figures shown may include options which are not available in the UK. Figures shown are for comparability purposes; only compare with other vans tested to the same technical procedures. Figures may not reflect real life driving results, which will depend upon a number of factors including factory-fitted options, accessories fitted (post registration), variations in weather, driving styles and vehicle load. Further information about the test used to establish fuel consumption and CO<sub>2</sub> figures can be found at <https://www.mercedes-benz.co.uk/vans/en/WLTP>

# Dimensions.



RETURN TO START

## eVito Tourer L2

<b>Wheelbase</b>	Wheelbase length	3,200mm
	Turning circle	12.9m
	Front track width	1,660mm
	Rear track width	1,648mm
<b>Vehicle</b>	Length	5,140mm
	Height (unladen)	1,930mm
	Width (inc. wing mirrors)	2,244mm
	Ground clearance	106mm
<b>Load compartment</b>	Length	2,653mm*
	Max. width	1,665mm
	Width between wheel arches	1,205mm
	Height	1,326mm

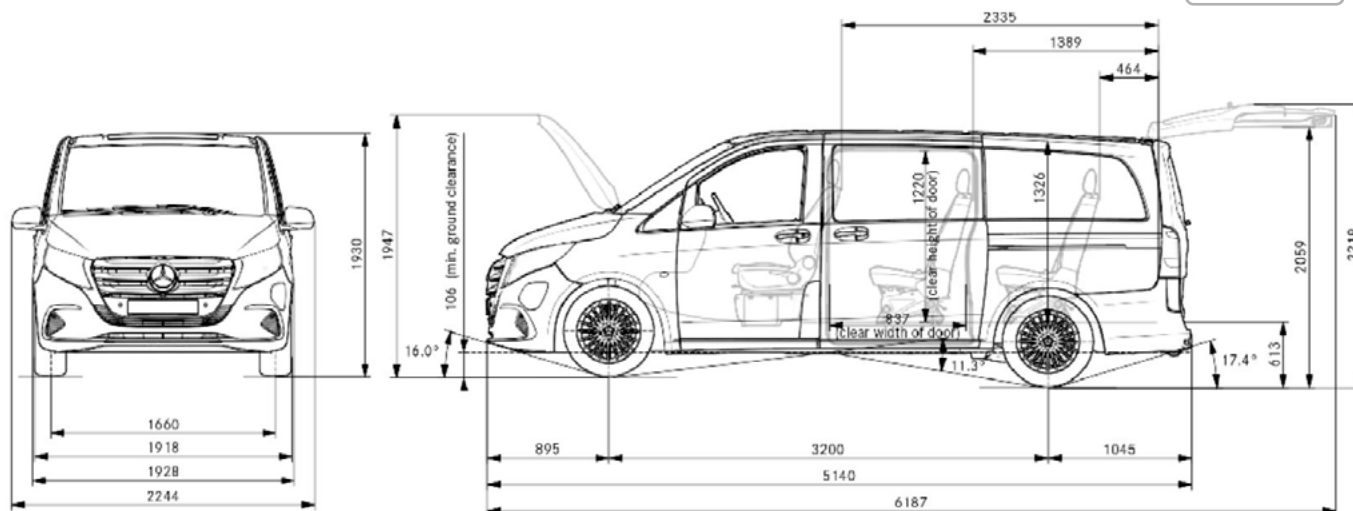

Dimensions may vary according to trim level.

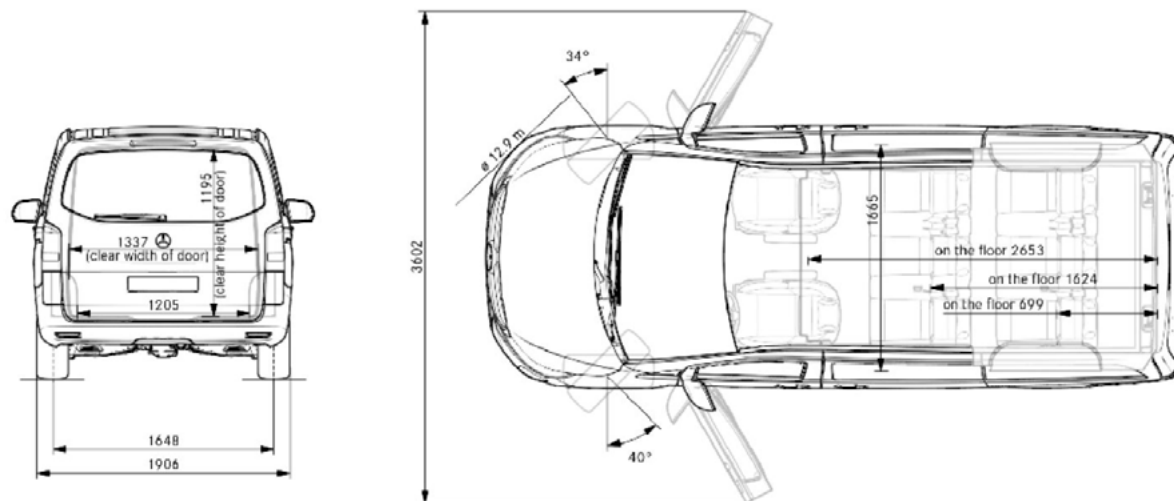

\* Measured on vehicle floor and includes 370mm for the space beneath the front seats.

# Dimensions.



RETURN TO START

## eVito Tourer L3

<b>Wheelbase</b>	Wheelbase length	3,430mm
	Turning circle	13.7m
	Front track width	1,660mm
	Rear track width	1,648mm
<b>Vehicle</b>	Length	5,370mm
	Height (unladen)	1,927mm
	Width (inc. wing mirrors)	2,244mm
	Ground clearance	106mm
<b>Load compartment</b>	Length	2,883mm*
	Max. width	1,665mm
	Width between wheel arches	1,205mm
	Height	1,297mm

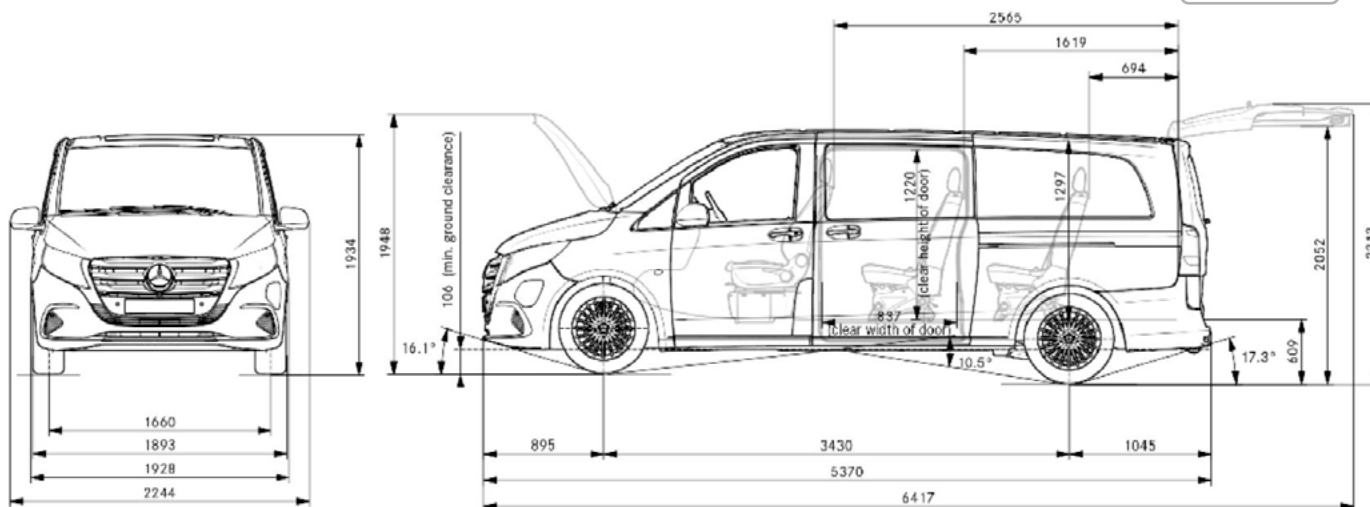

Dimensions may vary according to trim level.

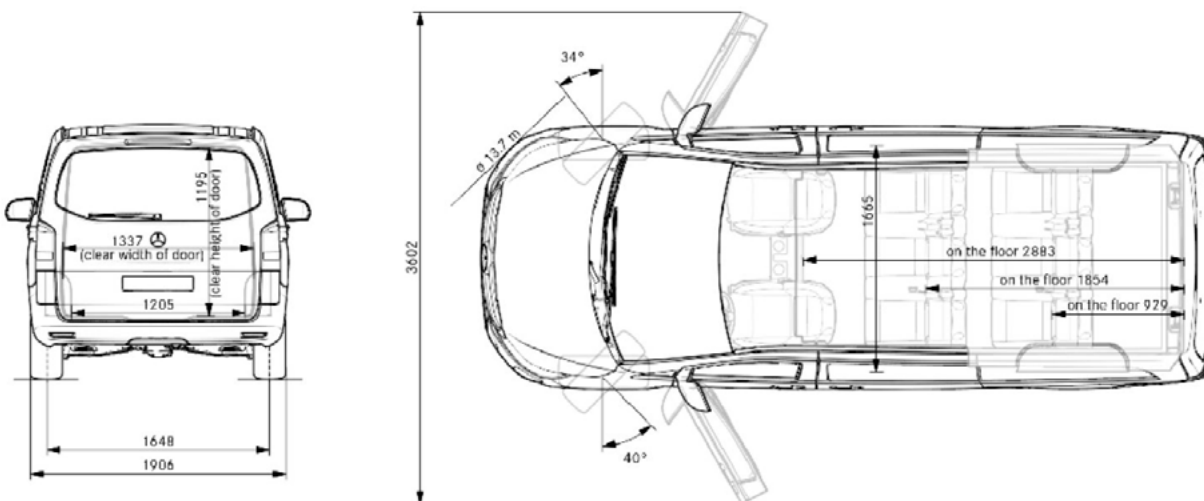

\* Measured on vehicle floor and includes 370mm for the space beneath the front seats.

# Mercedes-Benz Electric Vans and the Environment.



RETURN TO START

A key advantage of any battery electric vehicle (BEV) is its positive environmental impact, compared to an internal combustion (ICE) vehicle. Mercedes-Benz electric vans produce no tailpipe emissions.

See right for the Energy Efficiency Rating and emission standards compliance.

### Environmental data, Mercedes-Benz electric vans

CO<sub>2</sub> is the main greenhouse gas responsible for climate change.

**0** **A** **Rating: A** 0g/km

1-50 **A**  
51-75 **B**

76-90 **C**  
91-100 **D**

101-110 **E**  
111-130 **F**

131-150 **H**  
151-170 **I**

171-190 **J**  
191-225 **K**

226-255 **L**  
256+ **M**

#### Emission standards

**ULEV** ✓  
Ultra Low Emission Vehicle **ULEV**

**ZEV** ✓  
Zero Tailpipe Emissions Vehicle **ZEV**

#### Air quality emission zone compliance

**ULEV** ✓  
Clean Air Zones (England and Wales) **CAZ**

**ULEZ** ✓  
Ultra Low Emission Zone (London) **ULEZ**

This vehicle(s) meets the emissions standard for private vans set by government under the Clean Air Zone (CAZ) framework for England and Wales currently in place until 2025. Stricter CAZ standards and restrictions could then apply. Some local authorities may also impose more stringent controls in certain areas. A ULEV meets the current government standard for an Ultra Low Emission Vehicle, stricter standards could apply in the future. See more about future CAZs [here](#).

## Ambition 2039

A core element of our sustainable business strategy is Ambition 2039, with which we already set the course in 2019 for a holistic approach to climate protection and air pollution control.

The ambition is to make our entire fleet of new vehicles net carbon-neutral along the entire value chain and over the vehicles' entire life cycle by 2039 – from development to the supplier network, in-house production, electrification of products to renewable energies in the use phase of electric vehicles and recycling of the vehicles to close the loop.



The Mercedes-Benz eVito Tourer

# The Mercedes-Benz App.



RETURN TO START

Monitor your van's status, location and security via your smartphone.



ASSISTANCE & AFTERCARE		FREE
<b>Telediagnosics &amp; Maintenance Management</b>	Receive a notification when wear is detected on diagnostic-capable parts such as brake pads and get advance notice of when a service is due allowing you to plan your workshop visit well in advance to minimise any impact on your business.	
<b>Remote Vehicle Diagnostics</b>	Your Dealer can assess your van's condition remotely allowing them to check if any other repairs are required ahead of a service.	
<b>Accident Recovery &amp; Breakdown Management</b>	Once an emergency call has been resolved or if you request breakdown assistance, further support is offered to help recover your van or to tow it to a Mercedes-Benz Service outlet.	
<b>Software updates</b>	Over-the-air software updates are sent directly to your van's head unit. This means you'll always know your software is up to date and you'll save time by avoiding additional workshop visits.	
VEHICLE SUPERVISION		FREE FOR 3 YEARS
<b>Vehicle Tracker</b>	See your van's location on the map in your app, making it easy to call or message your driver and re-route them to fit in another delivery or pick-up if a quicker route is available. The tracker is factory fitted equipment so it can't be easily removed if stolen.	
<b>Parked Vehicle Locator</b>	If you're within 1 mile of your van's parked location, the app can generate the most convenient walking route – very handy if you're in unfamiliar surroundings and on a busy schedule.	
REMOTE ACCESS		FREE FOR 3 YEARS
<b>Remote Retrieval of Vehicle Status</b>	Use your app to check on charge level, tyre pressure, mileage and trip information. Not only does this help you plan your day's journeys, it can save you admin time on tasks such as logging your mileage for expenses.	
<b>Remote Door Locking &amp; Unlocking</b>	The app allows you to check if your van is locked. If you lock your keys in the van or need to give another driver access, you can do it via the app, from any distance away. For added peace of mind, you'll receive an email notification when your vehicle is unlocked.	
EV SERVICES		FREE
<b>Pre-Entry Climate Control</b>	Climate control can be started remotely when your van is charging so energy used for heating will draw on the mains power to avoid depleting your battery. This means you'll have maximum comfort and battery range.	
<b>Display of Charging Stations &amp; Range on map</b>	The Mercedes-Benz App shows you charging stations in the surrounding area and enables you to set the preferred one as your destination. The range display in your app helps you plan a journey with confidence as it shows if you can reach your destination using your existing battery range.	

# Mercedes-Benz Approved Used Electric vans. Get used to more...

**More choice. More confidence. More quality – and more added extras.**

As a Mercedes-Benz Approved Used Electric customer, you'll have complete peace of mind as every van offers the same commitment to quality and workmanship as new and comes with:



12-24 month warranty option\*



Free MOT test failure cover\*\*  
covering you for £1,500

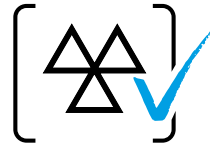

Minimum  
3 months MOT



Free 24/7 breakdown cover  
and roadside assistance^



Comprehensive  
multi-point vehicle check

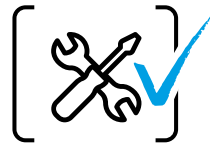

Discounted  
service plans

\*Warranty eligible up to 200,000 miles on approved used Mercedes-Benz Vans with less than 150,000 miles at point of sale. For full T&Cs, please speak to your preferred sales representative. \*\* MOT cover redeemable per 12-months warranty. £1,500 claims limit. For more information, please speak to your preferred sales representative. ^ Free for 12 months initially and renewed at each service, if serviced by MB according to service intervals for up to 30 years from when the vehicle was first registered. For a full list of exclusions and all product terms please visit [mbvans.co.uk/mobilovan](http://mbvans.co.uk/mobilovan) For full terms and conditions, please consult your local Dealer. Mercedes-Benz Van Insurance is a trading name of Mercedes-Benz Insurance Services UK Limited. Prices are correct at time of going to press 03/2026. All prices are subject to any fiscal or legislative changes.



Approved  
Used  
Electric



## What is an Approved Used van?

- Is no older than 6 years old
- Has less than 150,000 miles on the clock
- Is eligible for one of our flexible finance plans

➤ [Find more information and our latest Approved Used Electric offers](#)

## What is an Approved Used Electric van?

➤ [Visit our Dealer Networks Approved Used Electric van stock](#)

The Mercedes-Benz eVito Tourer

24



RETURN TO START

# All eVito models include an Integrated Service Package (ISP).

Integrated Service Package (ISP), helps to form an integral part of our commitment that the eVito is not only performing well but is safe to operate at all times.

Our ISP consists of four services: two A (minor) and two B (major) services as standard – and can be transferred to a new owner. All of our electric vehicles also come with out of charge cover and an 8year/100,000 mile battery capacity warranty as standard.



# Service24: Demand more

## The most comprehensive Aftercare package – for businesses that demand more.

Our 120-strong Dealer network works around the clock to service and maintain your vans and keep your business moving. It all adds up to more value, more flexibility and more confidence that you'll only find at an authorised Mercedes-Benz Dealer.

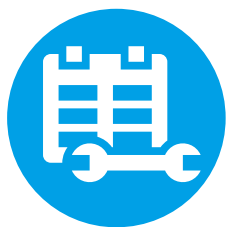

### › Flexible servicing and maintenance

Book your service online or by telephone, and as well as a standard 'drop and go' service with a courtesy van, you'll also get:

- Early bird, late night and weekend slots
- Mobile service
- Overnight service
- Collect & deliver service
- Express 1hr service
- Electric van service.

[Find out more about service and repairs](#)



### › Flexible ways to pay and save

With fixed, transparent national pricing there are no surprises with our services and repairs – plus you can fix, spread and reduce your service and maintenance costs, and ease your cashflow at the same time, with a payment plan.

- Pay as You Go
- ServiceCare Maintenance
- ServiceCare Flex (specifically for fleets)
- ServiceCare Complete.

[Find out more about service options](#)



### › 3-year unlimited mileage warranty

Available on every new van, all service and maintenance – and any work required – is covered by your 3-year unlimited mileage warranty, and is only undertaken by Mercedes-Benz trained technicians using Mercedes-Benz GenuineParts.

### › 8 year/100,000 mile battery certificate

For peace of mind and reliable performance, the eVito's battery comes with an impressive 8 year/100,000 mile battery guarantee.

[Find out more about warranties](#)

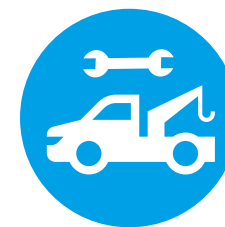

### › Free breakdown cover & roadside assistance\*

Every van comes with free Europe-wide breakdown cover – MobiloVan. And with 3 years' cover on new vehicles for driver mishaps, no one goes further to keep your business moving.

- Trained technicians using only Mercedes-Benz GenuineParts
- Out of charge cover for electric vehicles
- Forward travel of load and crew is covered
- Driver mishap cover for the first 3 years, including out of charge cover or empty fuel tanks.

[Find out more about MobiloVan](#)

\*For a full list of exclusions and all product terms please visit [www.mercedes-benz.co.uk/vans/en/Owners/MobiloVan](http://www.mercedes-benz.co.uk/vans/en/Owners/MobiloVan)

The Mercedes-Benz eVito Tourer

26

May 2026

Mercedes-Benz UK Limited, Delaware Drive, Tongwell, Milton Keynes, MK15 8BA. Company number: 02448457

[www.mercedes-benz.co.uk](http://www.mercedes-benz.co.uk)